

UNITED STATES OF AMERICA
BEFORE THE
FEDERAL ENERGY REGULATORY COMMISSION

Electricity Market Design and Structure)

Docket No. RM01-12-000

REQUEST FOR CONSIDERATION OF
INTERCONNECTED OPERATIONS SERVICES
IN STANDARD MARKET DESIGN PRINCIPLES

The North American Electric Reliability Council (“NERC”) submits its reference document, *Interconnected Operations Services*,¹ for the Commission’s use in developing its upcoming Notice of Proposed Rulemaking on Standard Market Design Principles. The Commission Staff’s concept paper dated December 17, 2001, acknowledges the importance of coordinated operation of real-time markets and the provision of Ancillary Services in assuring the short-term reliability of the North American bulk electric systems. NERC urges the Commission to build on the work that NERC’s industry committees have already done on this important subject as it develops its standard market design principles.

NERC has long recognized Interconnected Operations Services (“IOS”) as elemental building blocks of the short-term operational reliability of the bulk electric grid. IOS, for example, include the continuous balancing of generation and demand through regulation and load following, the ability to respond to a power imbalance through frequency responsiveness and operating reserves, the provision of reactive power and voltage control, and black start

¹ The NERC Operating Committee approved Version 1.0 of the reference document, *Interconnected Operations Services*, in March 2001, following several years of work by various industry groups, most recently NERC’s Interconnected Operations Services Subcommittee. This draft Version 1.1 of the IOS Reference Document incorporates terms defined in the NERC Functional Model, as approved by the NERC Board of Trustees on June 12, 2001 and revised on January 20, 2002.

capability. NERC's IOS Subcommittee and its predecessors have worked for five years to refine the definitions and develop practical measures of IOS. In considering Standard Market Design Principles, the Commission should view IOS as elemental ingredients necessary for reliable operation of real-time markets.

IOS are closely related to Ancillary Services, which are commercial products defined in service agreements and tariffs. There are two major distinctions between IOS and Ancillary Services. First, IOS are elemental building blocks that may be physically measured. IOS may be bundled or packaged into commercial products, or Ancillary Services, that allow transmission users to provide or meet their obligations with respect to reliability services in accordance with regional market designs, regulations and tariffs. Second, IOS are those elemental services that are typically provided in a practical and physical sense by generators.²

Consideration of standard definitions and practical measures that are based on IOS will promote three things: reliability, market benefits for consumers, and the ability of suppliers to compete for their business. It will be counter-productive to market efficiencies and potentially harmful to reliability if market-based reliability services are inconsistent with the physical products that are actually provided by generators. The process of developing standard market design principles should ensure that the Ancillary Service markets recognize the importance of the elemental building blocks of reliability defined by IOS. In short, Ancillary Services are reliability products from the perspective of the market, while IOS define the consistent and measurable provision of those services by generation resources.

Perhaps nowhere else do market functions and reliability interact in a more balanced way than with IOS and Ancillary Services. The reliability of the system depends on the correct

² Loads and other control devices can in some cases be acceptable suppliers of IOS.

provision and deployment of IOS, but as load serving entities bear the cost responsibility for reliability services, they are entitled to a liquid market of consistently designed products from which to choose. Competition is a key element in energy policy, and the IOS measurements and definitions enable that competition by allowing a broad spectrum of suppliers to compete in providing the services. Also, the IOS concepts ensure consistent measurement and product definition so that customers are assured of receiving the services for which they paid.

NERC offers to provide an industry representative to review the basic concepts of IOS or to answer questions at a future technical conference in the standard market design principles proceeding, or to otherwise meet with Commission Staff to discuss these important issues.

NORTH AMERICAN ELECTRIC
RELIABILITY COUNCIL



David N. Cook
General Counsel

116-390 Village Blvd.
Princeton, NJ 08540-5731
(609) 452-8060



NORTH AMERICAN ELECTRIC RELIABILITY COUNCIL

Princeton Forrestal Village, 116-390 Village Boulevard, Princeton, New Jersey 08540-5731

Reference Document

Interconnected Operations Services

**Prepared by the
Interconnected Operations Services Subcommittee**

**Draft Version 1.1 with Proposed Revisions
Incorporating Functional Model Definitions**

February 21, 2002

Table of Contents

SECTION 1. OVERVIEW.....	1
1.1 SCOPE AND PURPOSE.....	1
1.2 DEFINITION OF TERMS.....	1
1.3 IOS ARE BUILDING BLOCKS OF RELIABILITY	3
SECTION 2. DESCRIPTION OF IOS	5
2.1 GENERATION AND DEMAND BALANCING IOS.....	5
<i>BALANCING AUTHORITY Obligations</i>	5
<i>Operating Reserves</i>	5
<i>Overview of Resource and Demand Balancing IOS</i>	6
<i>Description of REGULATION AND LOAD FOLLOWING</i>	7
<i>Description of Contingency Reserve</i>	7
<i>Transmission Losses</i>	8
<i>Energy Imbalance</i>	9
2.2 BULK ELECTRIC SYSTEM SECURITY IOS.....	9
<i>Reactive Power Supply from Generation Sources</i>	10
<i>Interconnection Requirements - Reactive</i>	10
<i>Frequency Response</i>	10
2.3 EMERGENCY PREPAREDNESS.....	11
SECTION 3. SAMPLE IOS STANDARDS.....	12
3.1 SAMPLE GENERAL REQUIREMENTS	12
<i>Introduction</i>	12
<i>Sample General Requirements – OPERATING AUTHORITY</i>	12
<i>Sample General Requirements – IOS SUPPLIER</i>	13
3.2 SAMPLE REGULATION AND LOAD FOLLOWING REQUIREMENTS	14
<i>Sample Requirements – BALANCING AUTHORITY</i>	14
<i>Sample Requirements – IOS SUPPLIER</i>	14
3.3. SAMPLE CONTINGENCY RESERVE REQUIREMENTS.....	16
<i>Sample Requirements – BALANCING Authority</i>	16
<i>Sample Requirements – IOS SUPPLIER</i>	16
3.4 SAMPLE REACTIVE POWER SUPPLY FROM GENERATION SOURCES REQUIREMENTS	18
<i>Sample Requirements – OPERATING AUTHORITY</i>	18
<i>Sample Requirements – IOS SUPPLIER</i>	18
3.5 SAMPLE FREQUENCY RESPONSE REQUIREMENTS.....	19
<i>Sample Requirements – BALANCING AUTHORITY</i>	19
<i>Sample Requirements – IOS SUPPLIER</i>	19
3.6 SYSTEM BLACK START CAPABILITY.....	20
<i>Sample Requirements – OPERATING AUTHORITY</i>	20
<i>Sample Requirements – IOS SUPPLIER</i>	20
SECTION 4. METHODS FOR IOS PERFORMANCE MEASUREMENT AND CERTIFICATION	22
4.1 INTRODUCTION.....	22
4.2 PERFORMANCE MEASUREMENT METHODS.....	22
<i>REGULATION and LOAD FOLLOWING Sample Performance Measures</i>	22
<i>Contingency Reserve Sample Performance Measures</i>	29
<i>REACTIVE POWER SUPPLY FROM GENERATION SOURCES Sample Performance Measures</i>	30
<i>FREQUENCY RESPONSE Sample Performance Measures</i>	30
<i>SYSTEM BLACK START CAPABILITY Sample Performance Measures</i>	31
4.3 CERTIFICATION METHODS.....	31
<i>Introduction to Certification Methods</i>	31
<i>OPERATING AUTHORITY Sample IOS Program Certification</i>	31
<i>General Certification – Sample Criteria</i>	32

<i>CONTINGENCY RESERVE Certification Method</i>	32
<i>REACTIVE POWER SUPPLY FROM GENERATION SOURCES Certification</i>	33
<i>FREQUENCY RESPONSE Certification</i>	33
<i>SYSTEM BLACK START CAPABILITY Certification</i>	34

Section 1. Overview

1.1 Scope and Purpose

This Interconnected Operations Services (IOS) Reference Document was developed by the Interconnected Operations Services Subcommittee in response to a directive from the NERC Operating Committee in November 2000. Version 1.0 of the IOS Reference Document was approved by the Operating Committee in March 2001. This draft Version 1.1 of the IOS Reference Document incorporates terms defined in the NERC Functional Model, as approved by the NERC Board of Trustees on June 12, 2001 and revised on January 20, 2002.

This IOS Reference Document:

- Defines and describes the characteristics of INTERCONNECTED OPERATIONS SERVICES (IOS)
- Describes the necessity of IOS as ‘reliability building blocks’ provided by generators (and sometimes loads) for the purpose of maintaining BULK ELECTRIC SYSTEM reliability.
- Explains the relationship between OPERATING AUTHORITIES and IOS SUPPLIERS in the provision of IOS.
- Provides sample standards that could be used to define the possible obligations of OPERATING AUTHORITIES and IOS SUPPLIERS in the provision of IOS
- Describes sample methods for performance measurement in the provision of IOS
- Describes sample methods for the certification of IOS RESOURCES.

1.2 Definition of Terms

The definitions of IOS described in this IOS Reference Document are as follows:

REGULATION. The provision of generation and load response capability, including capacity, energy, and MANEUVERABILITY, that responds to automatic controls issued by the BALANCING AUTHORITY.

LOAD FOLLOWING. The provision of generation and load response capability, including capacity, energy, and MANEUVERABILITY, that is dispatched within a scheduling period by the BALANCING AUTHORITY.

CONTINGENCY RESERVE. The provision of capacity deployed by the BALANCING AUTHORITY to reduce AREA CONTROL ERROR to meet the Disturbance Control Standard (DCS) and other NERC and Regional Reliability Council contingency requirements. CONTINGENCY RESERVES are composed of CONTINGENCY RESERVE–SPINNING and CONTINGENCY RESERVE–SUPPLEMENTAL.

REACTIVE POWER SUPPLY FROM GENERATION SOURCES. The provision of reactive capacity, reactive energy, and responsiveness from IOS RESOURCES, available to control voltages and support operation of the BULK ELECTRIC SYSTEM.

FREQUENCY RESPONSE. The provision of capacity from IOS RESOURCES that deploys automatically to stabilize frequency following a significant and sustained frequency deviation on the INTERCONNECTION.

SYSTEM BLACK START CAPABILITY. The provision of generating equipment that, following a system blackout, is able to: 1) start without an outside electrical supply; and 2) energize a defined portion of the transmission system. SYSTEM BLACK START CAPABILITY serves to provide an initial startup supply source for other system capacity as one part of a broader restoration process to re-energize the transmission system.

The six IOS above are a core set of IOS, but are not necessarily an exhaustive list of IOS. Other BULK ELECTRIC SYSTEM reliability services provided by generators or loads could potentially be defined as IOS.

The following related terms are used in this IOS Reference Document:

BALANCING AREA. An electrical system bounded by interconnection (tie-line) metering and telemetry. It controls generation (and controllable loads) directly to maintain its interchange schedule with other BALANCING AREAS and contributes to frequency regulation of the INTERCONNECTION.

BALANCING AUTHORITY. An entity that: integrates resource plans ahead of time, and maintains load-interchange-generation balance within its metered boundary and supports system frequency in real time.

BULK ELECTRIC SYSTEM. The aggregate of electric generating plants, transmission lines, and related equipment. The term may refer to those facilities within one electric utility, or within a group of utilities in which the transmission facilities are interconnected.

CONTINGENCY RESERVE – SPINNING. The portion of CONTINGENCY RESERVE provided from IOS RESOURCES consisting of:

- Generation synchronized to the system and fully available to serve load within T_{DCS} minutes of the contingency event; or
- Load fully removable from the system within T_{DCS} minutes of the contingency event.

CONTINGENCY RESERVE – SUPPLEMENTAL. The portion of CONTINGENCY RESERVE provided from IOS RESOURCES consisting of:

- Generation (synchronized or capable of being synchronized to the system) that is fully available to serve load within T_{DCS} minutes of the contingency event; or
- Load fully removable from the system within T_{DCS} minutes of the contingency event.

DEPLOY. To authorize the present and future status and loading of resources. Variations of the word used in this IOS Reference Document include DEPLOYMENT and DEPLOYED.

DYNAMIC TRANSFER. The provision of the real-time monitoring, telemetering, computer software, hardware, communications, engineering, energy accounting (including inadvertent interchange), and administration required to electronically move all or a portion of the real energy services associated with a generator or load out of one BALANCING AREA into another.

INTERCONNECTED OPERATIONS SERVICE (IOS). A service (exclusive of basic energy and transmission services) that is required to support the reliable operation of interconnected BULK ELECTRIC SYSTEMS.

INTERCONNECTION. Any one of the three major electric system networks in North America: Eastern, Western, and ERCOT.

IOS SUPPLIER. An entity that offers to provide, or provides, one or more IOS.

IOS RESOURCE. The physical element(s) of the electric system which is (are) capable of providing an IOS. Examples of an IOS RESOURCE may include one or more generating units, or a portion thereof, and controllable loads.

LOAD-SERVING ENTITY. An entity that: Secures energy and transmission (and related generation services) to serve the end user.

MANEUVERABILITY. The ability of an IOS RESOURCE to change its real- or reactive-power output over time. MANEUVERABILITY is characterized by the ramp rate (e.g., MW/minute) of the IOS RESOURCE and, for REGULATION, its acceleration rate (e.g., MW/minute²).

OPERATING AUTHORITY¹. An entity that:

1. Has ultimate accountability for a defined portion of the BULK ELECTRIC SYSTEM to meet one or more of three reliability objectives – generation/demand balance, transmission security, and/or emergency preparedness; and
2. Is accountable to NERC and one or more Regional Reliability Councils for complying with NERC and Regional Policies; and
3. Has the authority to control or direct the operation of generating resources, transmission facilities, or loads, to meet these Policies.

OPERATING RESERVE. That capability above firm system demand required to provide REGULATION, load forecasting error, equipment forced and scheduled outages, and other capacity requirements.

1.3 IOS Are Building Blocks of Reliability

IOS are the elemental ‘reliability building blocks’ from generation (and sometimes load) necessary to maintain BULK ELECTRIC SYSTEM reliability. These ‘reliability building blocks’ have historically been provided by integrated utilities, configured as CONTROL AREAS, using internally owned resources. In contrast, in many areas of North America today, the introduction of competitive electricity markets has resulted in restructuring to separate transmission and generation functions, as well as other traditionally integrated functions. Increasingly, some of the entities responsible for reliability of BULK ELECTRIC SYSTEMS do not own all of the resources necessary for reliability but must obtain these resources, in particular generator-provided services, through a market process or through commercial arrangements.

This IOS Reference Document identifies six basic reliability services from generation (and sometimes load) that must be provided, regardless of regulatory environment, market structure, or organizational framework, to ensure BULK ELECTRIC SYSTEM reliability. These functions are the raw materials that OPERATING AUTHORITIES must assemble for deployment on a regional and interconnection basis to achieve BULK ELECTRIC SYSTEM reliability.

The IOS presented in this paper were chosen as such because their unique physical characteristics lend themselves to separate measurement methods and reliability criteria. These IOS can be combined in various ways to support commercial relationships – simply because a function is an IOS should not

¹Examples of OPERATING AUTHORITIES, as used in the IOS Reference Document, include the following authorities defined in the NERC Functional Model: RELIABILITY AUTHORITY, BALANCING AUTHORITY, TRANSMISSION OPERATOR, TRANSMISSION SERVICE PROVIDER, and INTERCHANGE AUTHORITY. The IOS Reference Document uses the term OPERATING AUTHORITY when the reference generally applies to more than one functional authority. A specific functional authority is identified when the reference applies only to that authority.

naturally lead to the conclusion that the marketplace should buy and sell that specific IOS separately.

Figure 1 illustrates the relationship between the IOS and reliability objectives. Some of the ‘reliability building blocks’ from generation are used to achieve generation and load balance, which is fundamental to maintaining a stable BULK ELECTRIC SYSTEM and INTERCONNECTION frequency within defined limits. These generation and demand balancing IOS are REGULATION, LOAD FOLLOWING, and CONTINGENCY RESERVE.

Other IOS are used to maintain a secure transmission network. REACTIVE SUPPLY FROM GENERATION SOURCES and FREQUENCY RESPONSE are examples of IOS for system security.

Finally, IOS can be used for emergency preparedness and restoration, such as the IOS SYSTEM BLACK START CAPABILITY.

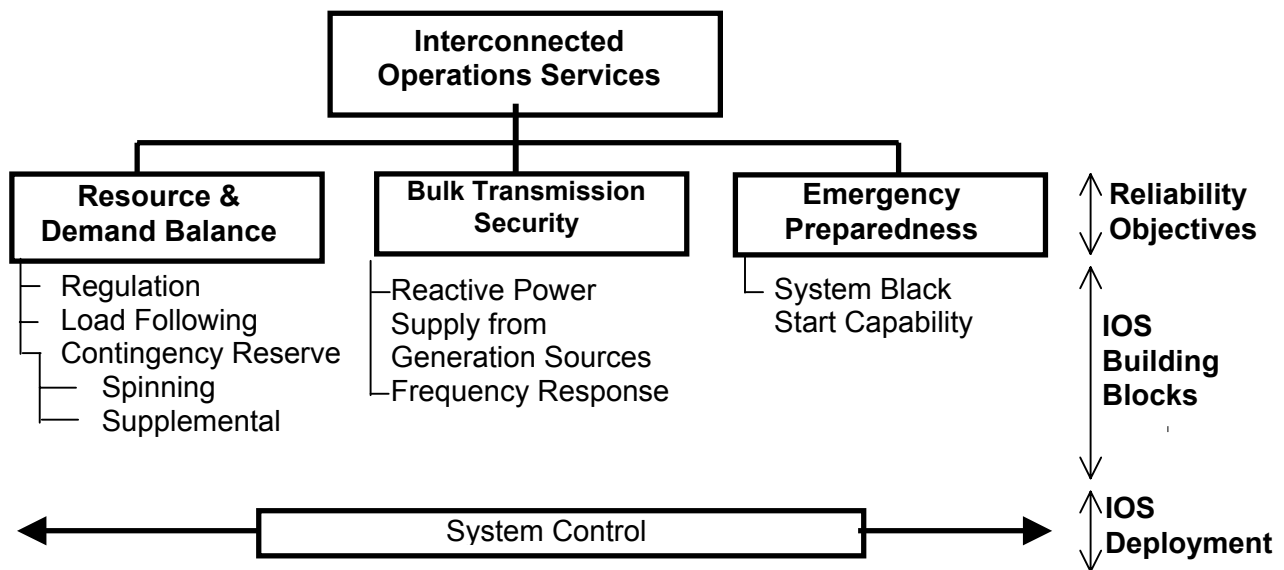

Figure 1 – IOS as Reliability Building Blocks

Section 2. Description of IOS

2.1 Generation and Demand Balancing IOS

BALANCING AUTHORITY Obligations

In their simplest form, generation and demand balancing IOS are capacity and the ability to raise and lower output or demand in response to control signals or instructions under normal and post-contingency conditions. Generators, controllable loads, or storage devices may provide these capabilities. Energy may also be delivered by a resource as a byproduct of providing the balancing capability.

The BALANCING AUTHORITY aggregates and deploys resources providing these services to meet the BALANCING AREA generation and demand balancing obligations, defined by control performance standards in NERC Operating Policy 1. These resources may supply a diverse mix of IOS, since balancing occurs in different time horizons and under both pre- and post-contingency conditions.

Section E of NERC Operating Policy 1 requires that a BALANCING AREA meet the following criteria²:

- **Control Performance Standard 1 (CPS1).** Over a year, the average of the clock-minute averages of a BALANCING AREA's ACE divided by $-10B$ (B is the BALANCING AREA frequency bias) times the corresponding clock-minute averages of the INTERCONNECTION'S frequency error shall be less than a specific limit;
- **Control Performance Standard 2 (CPS2).** The ten-minute average ACE must be within a specific limit (L_{10}) at least 90% of the time within each month; and
- **Disturbance Control Standard (DCS).** For reportable disturbances, the ACE must return either to zero or to its pre-disturbance level within a specified disturbance recovery time (defined in IOS Reference Document as T_{DCS} ³ minutes) following the start of a disturbance.

Operating Reserves

Policy 1 also requires a BALANCING AUTHORITY to provide a level of OPERATING RESERVES sufficient to account for such factors as forecasting errors, generation and transmission equipment unavailability, system equipment forced outage rates, maintenance schedules, regulating requirements, and load diversity. Policy 1 states that OPERATING RESERVES consist of REGULATION and CONTINGENCY RESERVES, and that OPERATING RESERVES can be used for the reasons listed above. OPERATING RESERVES may be comprised of: (1) available capacity from resources providing REGULATION and LOAD FOLLOWING services, (2) CONTINGENCY RESERVES, (3) available FREQUENCY RESPONSE capacity, and (4) load-serving reserves or backup supply.

Load-serving reserves are the responsibility of a LOAD-SERVING ENTITY. They are designed to account for errors in forecasting, anticipated and unanticipated generation/resource and transmission outages, and maintenance schedules that impact the delivery of energy to the LOAD-SERVING ENTITY. These reserves support the reliability of individual LOAD-SERVING ENTITIES, rather than the interconnected BULK

² NERC is in the process of developing a new standard title "Balance Resources and Demand" that incorporates CPS1, CPS2, and DCS as measures. The IOS Reference Document refers to the standards as they are currently defined in NERC Operating Policy 1.

³ The disturbance recovery time is defined in Policy 10 as a variable T_{DCS} to recognize that the specified recovery time stated in Policy 1 may change.

ELECTRIC SYSTEMS. As a result, they are not an IOS and are not addressed in this IOS Reference Document.

Overview of Resource and Demand Balancing IOS

Table 1 summarizes the IOS necessary to provide resource and demand balancing services and shows the reliability objective associated with each.

Table 1 – Overview of Resource and Demand Balancing IOS Objectives

IOS		Reliability Objective	
		Normal operating state	Post-contingency
REGULATION		Follow <u>minute-to-minute</u> differences between resources and demand.	
LOAD FOLLOWING		Follow resource and demand imbalances occurring within a scheduling period.	
FREQUENCY RESPONSE ⁴			Arrest deviation from scheduled frequency.
CONTINGENCY	SPINNING		Restore resource and demand balance, usually after a contingency.
RESERVES	SUPPLEMENTAL		Restore resource and demand balance after a contingency

Figure 2 compares the use and deployment period of the resource and demand balancing IOS.

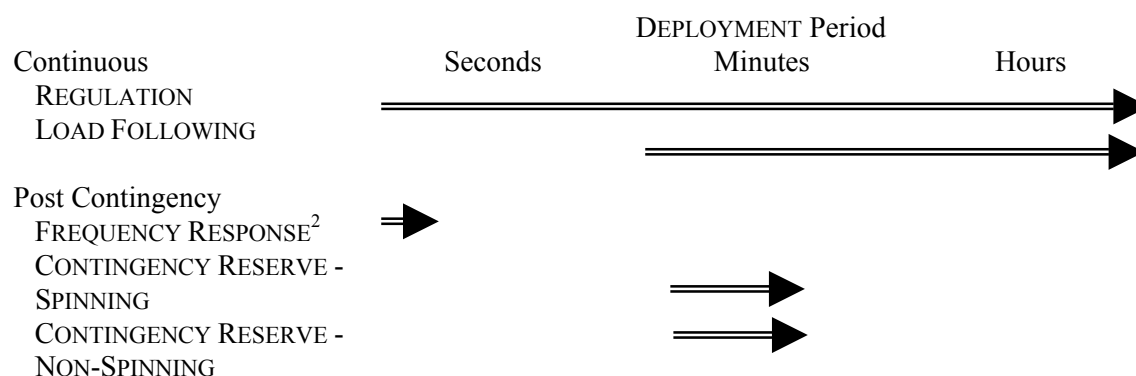

Figure 2 – Deployment Period for Resource and Demand Balancing IOS

⁴ In this IOS Reference Document, FREQUENCY RESPONSE is treated as an INTERCONNECTION security function, rather than a generation and demand balancing function. It is shown in Table 2 and Figure 2 only for the purpose of showing the deployment times relative to those of the resource and demand balancing IOS.

Description of REGULATION AND LOAD FOLLOWING

REGULATION and LOAD FOLLOWING require similar capabilities and are addressed together in this IOS Reference Document. A major difference is that LOAD FOLLOWING resources are deployed over a longer time horizon and over a generally wider range of output than resources providing REGULATION. The LOAD FOLLOWING burden imposed by individual loads tends to be highly correlated while the REGULATION burden tends to be largely uncorrelated.

REGULATION provides for resource and demand balancing in a time frame of minutes. The BALANCING AUTHORITY continuously determines the required changes (up and down) to the real power output of regulating resources to correct ACE to within CPS bounds.

LOAD FOLLOWING addresses longer-term changes in demand within scheduling periods. LOAD FOLLOWING resources, under automatic or manual control, chase (and to an extent anticipate) the longer term variations within a scheduling period. Figure 3 distinguishes the time horizons of REGULATION AND LOAD FOLLOWING IOS.

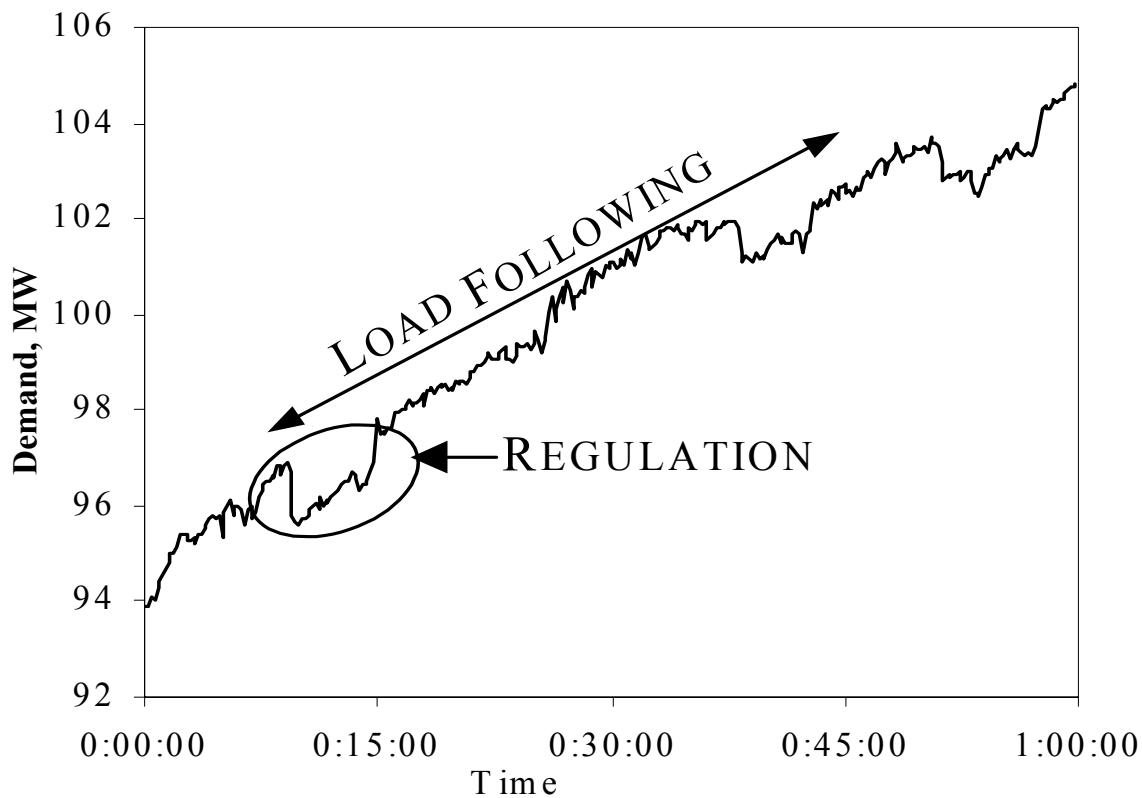

Figure 3 – REGULATION and LOAD FOLLOWING

Description of CONTINGENCY RESERVE

In addition to committing and controlling resources to ensure continuous balance between resources and demand, NERC Policy 1 requires a BALANCING AUTHORITY to return resources and demand to a balanced state (or at least to the same level of imbalance as the pre-contingency state) within ten minutes following a contingency. CONTINGENCY RESERVE provides standby capability to meet this requirement.

Following a contingency, FREQUENCY RESPONSE will immediately begin to arrest the frequency deviation across the INTERCONNECTION. Within the affected BALANCING AREA, resources providing REGULATION will begin to adjust outputs within seconds in response to signals from the BALANCING AREA's AGC. In addition, the BALANCING AUTHORITY may deploy, if necessary, CONTINGENCY RESERVE – SPINNING and SUPPLEMENTAL. These reserves are used to restore the pre-contingency resource and demand balance, FREQUENCY RESPONSE capacity, and REGULATION capacity. In all cases, the CONTINGENCY RESERVE must be sufficiently activated so that within T_{DCS} (or less) the pre-contingency resource/demand balance and FREQUENCY RESPONSE capacity are restored. Delivery of these reserves must be sustainable for the minimum reserve deployment period.

The time line below in Figure 4 graphically shows the operating relationship between FREQUENCY RESPONSE, CONTINGENCY RESERVE and an individual LOAD-SERVING ENTITY'S reserve or backup supply.

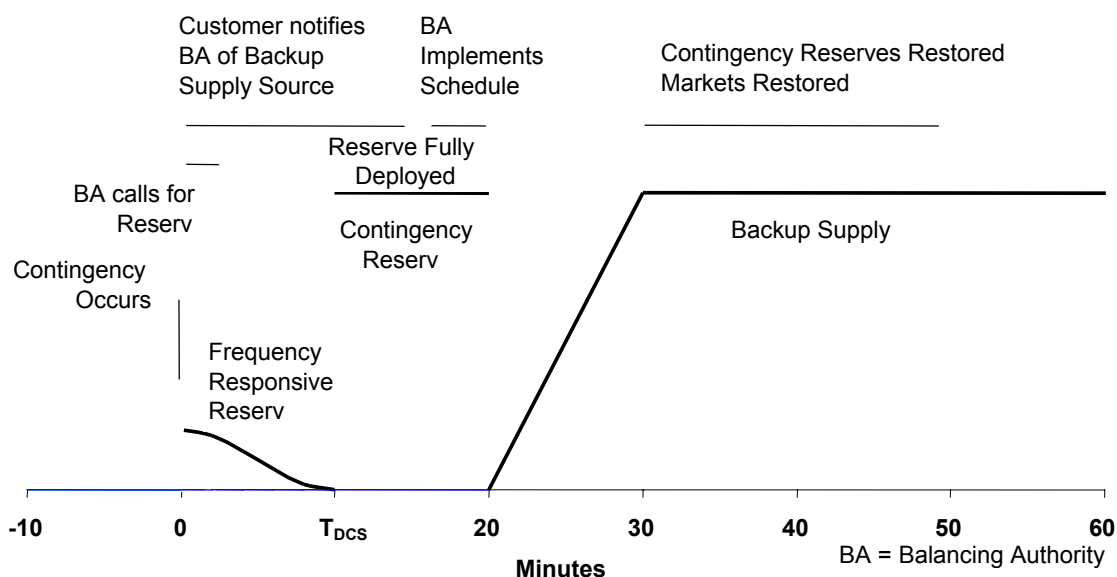

Figure 4 – Operating Reserve Timeline

Coordinated post-contingency operating plans are necessary to ensure BALANCING AUTHORITIES are able to deploy and restore CONTINGENCY RESERVE in a timely manner. These plans must outline the reserve obligations of BALANCING AUTHORITIES, other OPERATING AUTHORITIES, and LOAD-SERVING ENTITIES. These arrangements should delineate when and how schedules will be curtailed, which BALANCING AUTHORITY is responsible to deploy CONTINGENCY RESERVE, and when and how replacement schedules, if any, will be implemented.

Transmission Losses

Although the previous discussion focused on the mismatch between resources and demand due to randomly varying loads as well as control and scheduling errors, the losses associated with use of the transmission system must also be recognized. Real power losses are actually another type of demand and, if not compensated for, can cause a deficiency in reserves and system frequency degradation, thus threatening system reliability.

All electrical flows impact system losses. This includes transmission customer uses, native load uses, parallel flows, and other uses. All scheduled users of the transmission system are responsible for providing losses associated with their use of the system. The BALANCING AUTHORITY is responsible to balance total system demand, including losses.

The difference in real-time between actual system losses and resources scheduled to supply system losses is provided by REGULATION and LOAD FOLLOWING. For this reason, the IOS Reference Document does not treat losses as a separate IOS. Instead losses are handled in the market, through scheduling processes, in accordance with transmission tariffs and contracts. Any differences between scheduled and actual losses are addressed through REGULATION and LOAD FOLLOWING, or possibly through energy imbalance measures, if a transmission customer is delivering energy to compensate for losses.

Energy Imbalance

Energy and scheduling imbalances are measures of how well a transmission customer is meeting its balancing obligations at a specific point or points on the system. Such imbalances are calculated as the difference between actual and scheduled energy at a point of receipt or point of delivery over a scheduling period.

The provision of resource and demand balancing in a pre-contingency state for a transmission customer is done through the use of scheduled delivery of resources to serve the transmission customer's load, along with the provision of REGULATION and LOAD FOLLOWING.

Although existing transmission tariffs may treat energy imbalance as a service, the IOS Reference Document considers energy imbalance, including scheduling imbalances with generators, as energy mismatch measurements. Energy imbalance is a measure of historical performance averaged over a time period. IOS are *capabilities* that are deployed in the present and future to meet reliability objectives. Both energy imbalance and IOS can be measured, and can have reliability criteria and economic terms. However, energy imbalance only describes past performance, while IOS are services that may be deployed now and in the future for reliability purposes.

2.2 Bulk Electric System Security IOS

System security refers to the ability of BULK ELECTRIC SYSTEMS to withstand sudden disturbances such as electric short circuits or unanticipated loss of system elements.

Two fundamental capabilities needed to maintain BULK ELECTRIC SYSTEM security are the ability to⁵:

1. Maintain system voltages within limits to maintain INTERCONNECTION reliability under normal and emergency conditions. This is accomplished by coordinating the following minimum components of transmission system voltage control:
 - Load power factor correction;
 - Transmission reactive compensation (capacitors, reactors, static var compensators, etc.);
 - Generator interconnection requirements with the transmission provider (relay and control, power factor, voltage, etc.);

⁵ Refer to Operating Policy 2 B and Planning Policy I D for Control Area standards related to voltage control.

- OPERATING AUTHORITY coordination; and
 - REACTIVE POWER SUPPLY FROM GENERATION SOURCES (IOS)
2. Automatically and rapidly arrest frequency excursions due to contingencies on BULK ELECTRIC SYSTEMS. This capability constitutes the FREQUENCY RESPONSE IOS.

REACTIVE POWER SUPPLY FROM GENERATION SOURCES

REACTIVE POWER SUPPLY FROM GENERATION SOURCES comprises the following essential capabilities from generators (and possibly some loads): reactive capacity, reactive energy, dynamic and fast-acting responsiveness through the provision and operation of an Automatic Voltage Regulator (AVR), and the ability to follow a voltage schedule. REACTIVE POWER SUPPLY FROM GENERATION SOURCES is used by the OPERATING AUTHORITY to maintain system voltages within established limits, under both pre- and post-contingency conditions, and thereby avoid voltage instability or system collapse.

Interconnection Requirements - Reactive

In addition to the use of this generation-based IOS, the OPERATING AUTHORITY maintains transmission security through the coordinated use of static reactive supply devices throughout the system, and may develop and impose reactive criteria on LOAD-SERVING ENTITIES. Requirements for the non-generator components are addressed in NERC, Regional Reliability Council, and local standards and interconnection requirements.

As an example, minimum interconnection requirements include NERC Planning Standard III C S1, which states: “All synchronous generators connected to the interconnected transmission systems shall be operated with their excitation system in the automatic voltage control mode unless approved otherwise by the transmission system operator.” The intent is that there be no supplementary excitation control (reactive power or power factor control) that limits emergency reactive power output to less than reactive power capability.

Generator power factor and voltage regulation standards can be a condition of interconnection to satisfy area or local system voltage conditions. Voltage regulating capacity and capabilities that are provided to meet minimum interconnection requirements do not imply that those generators are qualified IOS SUPPLIERS.

FREQUENCY RESPONSE

FREQUENCY RESPONSE is the capability to change, with no manual intervention, an IOS RESOURCE’s real power output in direct response to a deviation from scheduled frequency.

The need for FREQUENCY RESPONSE extends beyond the boundaries of a BALANCING AREA to meet the reliability needs of the INTERCONNECTION. Hence it is aligned with a transmission security objective rather than the resource and demand balancing objective. FREQUENCY RESPONSE is not required to meet the BALANCING AREA needs related to DCS. CONTINGENCY RESERVE is used for that purpose.

FREQUENCY RESPONSE is achieved through an immediate governor response to a significant change in INTERCONNECTION frequency. The cumulative effect of the governor response within the INTERCONNECTION provides an INTERCONNECTION-wide response to a frequency deviation (i.e., all BALANCING AREAS will “see” a frequency change and contribute their frequency response in proportion to the frequency change). This governor action arrests the frequency deviation and allows other slower

responding control actions to effectively restore system frequency and affected BALANCING AREA's ACE.

2.3 Emergency Preparedness

Emergency preparedness refers to the measures taken to prepare for the rare occasions when all or a major portion of a BULK ELECTRIC SYSTEM or INTERCONNECTION is forced out of service. When this occurs, the capability must exist to restore normal operations as quickly as possible. This is called system restoration. System restoration requires:

- SYSTEM BLACK START CAPABILITY – Generating units that can start themselves without an external electricity source and can then energize transmission lines and restart other generating units;
- Non-black start generating units that can quickly return to service after offsite power has been restored to the station and can then participate in further restoration efforts;
- Transmission system equipment, controls, and communications (including ones that can operate without grid power), and field personnel to monitor and restore the electrical system after a blackout;
- System control equipment and communications (including ones that can operate without grid power); and
- Personnel to plan for and direct the restoration operations after such a blackout.

The IOS Reference Document deals only with the first of these five aspects of system restoration, as it is a critical reliability service that must be provided by generation resources. Other NERC Planning and Operating Standards address other elements of this service. NERC Planning Standard 4A, System Black Start Capability, states that: "Following the complete loss of system generation (blackout), it will be necessary to establish initial generation that can supply a source of electric power to other system generation and begin system restoration." These initiating generators are referred to as SYSTEM BLACK START CAPABILITY.

NERC Operating Policy 6 D, Operations Planning – System Restoration, requires: Each OPERATING AUTHORITY and Region shall develop and periodically update a logical plan to reestablish its electric system in a stable and orderly manner in the event of a partial or total shutdown of the system. For further reference, see Policy 5 E, Emergency Operations-System Restoration.

Section 3. Sample IOS Standards

3.1 Sample General Requirements

Introduction

Section 3.1 provides a sample of general requirements that may be applicable for all IOS. These sample general requirements establish a framework of responsibilities for:

- Development of IOS specifications and metrics for certification and performance evaluation.
- The provision of IOS, including planning, aggregation, and deployment.
- Monitoring and verification of IOS.

Specific sample standards for each IOS are provided in the remaining parts of Section 3. The sample standards throughout Section 3 are grouped into two main subheadings according to the type of entity to which the standards may apply: OPERATING AUTHORITY or IOS SUPPLIER.

The sample standards in the IOS Reference Document stipulate that the required amounts of each IOS are contingent upon the characteristics of the regional or local BULK ELECTRIC SYSTEMS. Such specific regional or local requirements should be developed through a process that is a) open to and inclusive of all market participants, and b) in accordance with the prevailing regional processes for standards development.

The sample IOS SUPPLIER requirements are intended to apply to all IOS RESOURCES regardless of ownership.

Sample General Requirements – OPERATING AUTHORITY

The statements below are provided for information only and do not infer mandatory requirements or a description of industry practices.

- 1. Provision of IOS.** The OPERATING AUTHORITY shall assure sufficient IOS are arranged, provided, and deployed to meet NERC, Regional Reliability Council, and local planning and operating standards.
- 2. Specify IOS Requirements.** The OPERATING AUTHORITY shall determine IOS requirements through an open and inclusive process that is consistent with regulatory requirements, is coordinated at a regional level, includes market stakeholders, and allows for dispute resolution. Regional and local IOS requirements include but are not limited to:
 - 2.1.** The quantity, response time, duration, location and other criteria for each IOS as necessary to meet NERC, Regional Reliability Council, and local planning and operating standards.
 - 2.2.** Written procedures for the arrangement, provision, and deployment of IOS.
 - 2.3.** Metering requirements, consistent with established industry practices, for IOS RESOURCES.

- 2.4. Voice and data communication requirements associated with provision and delivery of IOS.
- 2.5. Transmission service requirements for delivery of each IOS.
3. **Changing System Conditions.** IOS requirements and procedures shall be adapted as necessary to maintain system reliability in response to current or expected system conditions.
4. **Publication of IOS Requirements.** The OPERATING AUTHORITY shall maintain publicly available documents specifying IOS requirements and procedures.
5. **Performance Verification.** The OPERATING AUTHORITY shall monitor the actual performance of IOS RESOURCES under normal and/or disturbance conditions to verify the IOS RESOURCE meets published performance criteria.

Sample General Requirements – IOS SUPPLIER

The statements below are provided for information only and do not infer mandatory requirements or a description of industry practices.

7. **IOS RESOURCE Capabilities.** An IOS SUPPLIER shall provide IOS RESOURCES which are:
 - 7.1. Able to deliver the stated IOS capabilities to the BULK ELECTRIC SYSTEM.
 - 7.2. Responsive to the instructions and controls of the OPERATING AUTHORITY, as specified for each IOS and consistent with previously agreed upon terms and conditions between the IOS SUPPLIER and OPERATING AUTHORITY.
8. **IOS RESOURCE Certification.** The capabilities of IOS RESOURCES shall be certified according to the defined minimum criteria. (See IOS Reference Document Section 4.3 for certification criteria.)
9. **Metering.** An IOS SUPPLIER shall provide and maintain metering to measure IOS capabilities and performance, as specified by published IOS requirements.
10. **Voice and Data Communications.** An IOS SUPPLIER shall provide and maintain voice and data communications, as specified by published IOS requirements, to enable:
 - 10.1. IOS RESOURCES to respond to the instructions or controls of the OPERATING AUTHORITY.
 - 10.2. OPERATING AUTHORITIES to monitor the capabilities and verify the performance of IOS RESOURCES.
11. **Provision of IOS.** An IOS SUPPLIER shall, as soon as practicable, notify the OPERATING AUTHORITY of any changes in the capability to provide the service or meet stated obligations.
12. **Performance Verification.** Upon request, an IOS SUPPLIER shall provide information to the OPERATING AUTHORITY necessary to verify performance, in accordance with published IOS requirements and procedures. All IOS SUPPLIERS, including OPERATING AUTHORITIES, which are

IOS SUPPLIERS, shall maintain and provide verifiable data for certification purposes.

- 13. Concurrent Commitment of IOS RESOURCES.** An IOS SUPPLIER may make concurrent commitments of an IOS RESOURCE's capability to provide IOS (for example providing recallable energy and CONTINGENCY RESERVE – SUPPLEMENTAL), if the following conditions are met:

13.1. The practice is disclosed, in advance, to the OPERATING AUTHORITY(IES) involved; and

13.2. The arrangements do not conflict with meeting the IOS SUPPLIER's obligations, nor the provision requirements of each concurrently committed IOS. For example, the same capacity for CONTINGENCY RESERVE may not be concurrently used for REGULATION.

3.2 Sample REGULATION and LOAD FOLLOWING Requirements

Sample Requirements – BALANCING AUTHORITY

The statements below are provided for information only and do not infer mandatory requirements or a description of industry practices.

- 1. Written Requirements.** The BALANCING AUTHORITY shall determine the IOS requirements for REGULATION and LOAD FOLLOWING in accordance with Requirement 2 of Section 3.1 – Operating Authority Sample Requirements. These requirements may include the amount, location, and response capabilities of IOS RESOURCES.
- 2. Provision.** The BALANCING AUTHORITY shall assure sufficient REGULATION and LOAD FOLLOWING capabilities are arranged, provided, and deployed to meet NERC, applicable Regional Reliability Council, and local planning and operating standards.
- 3. Deployment.** The BALANCING AUTHORITY shall direct the current and future loading of the portion of IOS RESOURCES providing REGULATION or LOAD FOLLOWING. Loading refers to the energy delivery of the IOS RESOURCE, within the operating constraints committed by the IOS SUPPLIER.
- 4. IOS SUPPLIER Performance Monitoring.** The BALANCING AUTHORITY shall monitor the REGULATION and LOAD FOLLOWING performance of IOS SUPPLIERS. The BALANCING AUTHORITY shall maintain records of IOS SUPPLIER performance and data used to calculate performance.

Sample Requirements – IOS SUPPLIER

The statements below are provided for information only and do not infer mandatory requirements or a description of industry practices.

- 5. Declaration of REGULATION Response Capability.** An IOS SUPPLIER that has agreed to provide REGULATION shall declare to the BALANCING AUTHORITY the IOS RESOURCE's:
 - 5.1.** Maximum and minimum outputs that define the REGULATION range of the IOS RESOURCE.
 - 5.2.** MANEUVERABILITY characteristics including ramp up and ramp down limit, minimum

time between requests for control changes, and maximum and minimum acceleration.

6. **Declaration of LOAD FOLLOWING Response Capability.** An IOS SUPPLIER providing LOAD FOLLOWING shall declare to the BALANCING AUTHORITY the IOS RESOURCE's:
 - 6.1. Maximum and minimum outputs that define the LOAD FOLLOWING range of the IOS RESOURCE.
 - 6.2. The ramp rate and acceleration of the IOS RESOURCE.
 - 6.3. The minimum time period between requests for load changes.
7. **REGULATION Response.** An IOS RESOURCE that is offered to provide REGULATION shall automatically change the real power output in response to the controls supplied by the BALANCING AUTHORITY, subject to the agreed upon REGULATION capabilities of the IOS RESOURCE.
8. **LOAD FOLLOWING Response.** An IOS RESOURCE that is offered to provide LOAD FOLLOWING shall increase or decrease its real power output in response to instructions from the BALANCING AUTHORITY, subject to the agreed upon LOAD FOLLOWING capabilities of the IOS RESOURCE.
9. **Metering and Communication.** An IOS SUPPLIER offering to provide REGULATION or LOAD FOLLOWING shall meet the following minimum metering and communication requirements:
 - 9.1. The IOS RESOURCE shall have a BALANCING AUTHORITY approved data communication service between the IOS RESOURCE control interface and the BALANCING AREA.
 - 9.2. The IOS RESOURCE shall have a BALANCING AUTHORITY approved voice communication service to provide both primary and alternate voice communication between the BALANCING AUTHORITY and the operator controlling the IOS RESOURCE.
 - 9.3. The IOS SUPPLIER shall provide to the BALANCING AUTHORITY real-time telemetry of the real power output of each IOS RESOURCE. The update frequency for REGULATION and LOAD FOLLOWING shall be in accordance with the requirements and guides in Operating Policy 1. The availability and reliability of the telecommunications shall comply with Operating Policy 7.
10. **REGULATION and LOAD FOLLOWING IOS RESOURCES Outside of the BALANCING AREA.** IOS SUPPLIERS providing REGULATION or LOAD FOLLOWING from IOS RESOURCES located in a BALANCING AREA other than the BALANCING AREA in which the load is physically connected, shall be controlled by a DYNAMIC TRANSFER.

3.3. Sample CONTINGENCY RESERVE Requirements

Sample Requirements – BALANCING Authority

The statements below are provided for information only and do not infer mandatory requirements or a description of industry practices.

- 1. Written Requirements.** The BALANCING AUTHORITY shall determine the IOS requirements for CONTINGENCY RESERVE – SPINNING, and CONTINGENCY RESERVE – SUPPLEMENTAL in accordance with Requirement 2 of Section 3.1 – Operating Authority Sample Requirements. These requirements may include the amount, location, and response characteristics, allowed overshoot, and the portion of CONTINGENCY RESERVE that must be SPINNING or SUPPLEMENTAL.
- 2. Provision.** The BALANCING AUTHORITY shall assure sufficient capabilities for CONTINGENCY RESERVE – SPINNING and SUPPLEMENTAL are arranged, provided, and deployed to meet NERC, applicable Regional Reliability Council, and local operating requirements.
- 3. CONTINGENCY RESERVE Dispersion.** CONTINGENCY RESERVES dispersion shall consider the effective use of capacity in an emergency, time required to be effective, transmission limitations, and local area requirements.
- 4. Deployment of CONTINGENCY RESERVE – SPINNING AND SUPPLEMENTAL.** The BALANCING AUTHORITY shall direct the loading of IOS RESOURCES that provide CONTINGENCY RESERVE – SPINNING and SUPPLEMENTAL. The BALANCING AUTHORITY shall ensure deployment capability within the required recovery time from disturbance conditions (T_{DCS}) specified in Operating Policy 1. The BALANCING AUTHORITY shall ensure deployment of CONTINGENCY RESERVE is sustainable for a minimum of 30 minutes following the contingency event.
- 5. Verification of Performance.** The BALANCING AUTHORITY shall verify that all IOS RESOURCES requested to provide CONTINGENCY RESERVE – SPINNING, and SUPPLEMENTAL do so according to established performance criteria, including reaching the requested amount of real power output within and for the specified time limits.
- 6. Restoration of CONTINGENCY RESERVE.** The BALANCING AUTHORITY shall develop clear operating plans and procedures to assure the timely deployment and restoration of CONTINGENCY RESERVE. These plans and procedures shall specify how CONTINGENCY RESERVE shall be restored, for example, how and when schedules are curtailed, replaced, or initiated.

Sample Requirements – IOS SUPPLIER

The statements below are provided for information only and do not infer mandatory requirements or a description of industry practices.

- 7. Declaration of CONTINGENCY RESERVE Capability.** An IOS SUPPLIER that has agreed to provide CONTINGENCY RESERVE shall declare to the BALANCING AUTHORITY the IOS RESOURCE'S capabilities.
- 8. IOS RESOURCE Response.** An IOS RESOURCE offered to provide CONTINGENCY RESERVES shall be:

- 8.1. Responsive to the instructions and/or variable scheduled output supplied by the BALANCING AUTHORITY.
 - 8.2. Continuously synchronized to the system, when providing CONTINGENCY RESERVES – SPINNING SERVICE.
 - 8.3. Available for redeployment after the pre-arranged elapsed time as specified by the IOS SUPPLIER.
9. **Provision of CONTINGENCY RESERVES.** In response to the instructions of the BALANCING AUTHORITY, and subject to the declared capabilities of the IOS RESOURCE, the IOS RESOURCE shall:
- 9.1. Provide between 100% and the allowed overshoot of the stated amount (MW) of CONTINGENCY RESERVE – SPINNING within ($T_{DCS} - X$) minutes of a call by the BALANCING AUTHORITY requesting CONTINGENCY RESERVE. X is the number of minutes agreed to in advance by the BALANCING AUTHORITY and IOS SUPPLIER that allows for the BALANCING AUTHORITY to respond to a contingency and call for deployment of CONTINGENCY RESERVE.
 - 9.2. Maintain between 100% and the allowed overshoot of the stated amount (MW) of CONTINGENCY RESERVE – SPINNING for at least 15 minutes subsequent to ($T_{DCS} - X$).
 - 9.3. Return to the non-contingency scheduled output (or consumption) +/- 10% of the requested amount of CONTINGENCY RESERVE, within ten minutes of instructions from the BALANCING AUTHORITY to do so. Alternatives to the +/- 10% bandwidth and the ten minute period may be established by the BALANCING AUTHORITY through an open process defined in Requirement 2 - Section 3.1 – OPERATING AUTHORITY Requirements.
10. **Maintaining Reserve Capacity.** An IOS SUPPLIER shall maintain the capacity committed to provide CONTINGENCY RESERVE throughout the commitment period.
11. **Metering and Communication.** An IOS SUPPLIER offering to provide CONTINGENCY RESERVE shall meet the following minimum metering and communication requirements:
- 11.1. The IOS SUPPLIER shall provide to the BALANCING AUTHORITY real-time telemetry of the real power output of each IOS RESOURCE providing CONTINGENCY RESERVE.
 - 11.2. The IOS RESOURCE shall have a BALANCING AUTHORITY approved data communication service between the IOS RESOURCE control interface and the BALANCING AREA.
 - 11.3. The IOS RESOURCE shall have a BALANCING AUTHORITY approved voice communication service to provide both primary and alternate voice communication between the BALANCING AUTHORITY and the operator controlling the IOS RESOURCE.

3.4 Sample REACTIVE POWER SUPPLY FROM GENERATION SOURCES Requirements

Sample Requirements – OPERATING AUTHORITY

The statements below are provided for information only and do not infer mandatory requirements or a description of industry practices.

1. **Voltage Schedule Coordination.** The OPERATING AUTHORITY shall establish, and update as necessary, voltage schedules at points of integration of REACTIVE POWER SUPPLY FROM GENERATION SOURCES, to maintain system voltages within established limits and to avoid burdening neighboring systems. The OPERATING AUTHORITY shall communicate to the IOS SUPPLIER the desired voltage at the point of integration.

IOS RESOURCE here refers only to those resources providing REACTIVE POWER SUPPLY FROM GENERATION SOURCES.
2. **Reactive Reserves.** The OPERATING AUTHORITY shall acquire, deploy, and continuously maintain reactive reserves from IOS RESOURCES, both leading and lagging, adequate to meet contingencies.
3. **Telemetry.** The OPERATING AUTHORITY shall monitor by telemetry the following data:
 - 3.1. Transmission voltages.
 - 3.2. Unit or IOS RESOURCE reactive power output.
 - 3.3. Unit or IOS RESOURCE Automatic Voltage Regulator (AVR) status for units greater than 100 MW (and smaller units where an identified need exists).
4. **NERC Planning Standards.** The OPERATING AUTHORITY shall comply with NERC Planning Standards applicable to reactive power capability. These standards require that generation owners and OPERATING AUTHORITIES plan and test reactive power capability.

Sample Requirements – IOS SUPPLIER

The statements below are provided for information only and do not infer mandatory requirements or a description of industry practices.

5. **Automatic Voltage Regulator.** An IOS RESOURCE shall operate with the unit's AVR in use during the schedule period in which REACTIVE POWER SUPPLY FROM GENERATION SOURCES is provided, unless specifically directed to operate in manual mode by the OPERATING AUTHORITY, or a need to operate in manual mode is identified for emergency reasons by the IOS SUPPLIER. When the IOS SUPPLIER changes the mode, the IOS SUPPLIER shall promptly inform the OPERATING AUTHORITY.
6. **Response to Voltage or Reactive Power Schedule Changes.** IOS RESOURCES shall meet, within established tolerances, and respond to changes in the voltage or reactive power schedule established by the OPERATING AUTHORITY, subject to the stated IOS RESOURCE reactive and real power operating characteristic limits and voltage limits.

7. **Reactive Capacity.** IOS RESOURCES shall maintain stated reactive capacity, both leading and lagging. An IOS RESOURCE's stated lagging reactive capacity shall be supplied without interruption or degradation when subject to sudden and large voltage drops.
8. **Telemetry.** IOS RESOURCES shall provide electronic transfer of real-time information to the OPERATING AUTHORITY:
 - 8.1. Voltages at the IOS RESOURCE point of delivery to the OPERATING AUTHORITY.
 - 8.2. IOS RESOURCE reactive power output, and
 - 8.3. IOS RESOURCE AVR status for units of greater than 100 MW of nameplate capacity (and smaller units where an identified need exists).

3.5 Sample FREQUENCY RESPONSE Requirements

Sample Requirements – BALANCING AUTHORITY

The statements below are provided for information only and do not infer mandatory requirements or a description of industry practices.

1. **Written Requirements.** The BALANCING AUTHORITY shall determine the IOS requirements for FREQUENCY RESPONSE in accordance with Requirement 2 of Section 3.1 – Operating Authority Sample Requirements. These requirements may include the amount, location, and response characteristics.
2. **Provision.** The BALANCING AUTHORITY shall assure sufficient capabilities for FREQUENCY RESPONSE are arranged, provided, and deployed to meet NERC, applicable Regional Reliability Council, and local operating requirements.
3. **Verification of Performance.** The BALANCING AUTHORITY shall verify that all IOS RESOURCES contracted to provide FREQUENCY RESPONSE do so according to established performance criteria, including reaching the requested amount of real power output within and for the specified time limits.

Sample Requirements – IOS SUPPLIER

The statements below are provided for information only and do not infer mandatory requirements or a description of industry practices.

4. **Declaration of FREQUENCY RESPONSE Capability.** Prior to providing FREQUENCY RESPONSE, the IOS SUPPLIER shall declare the FREQUENCY RESPONSE capabilities of the IOS RESOURCES.
5. **Governor.** An IOS RESOURCE providing FREQUENCY RESPONSE capability shall maintain an operable governor system and shall be responsive to system frequency deviations.
6. **Maintaining FREQUENCY RESPONSE Capacity.** An IOS SUPPLIER shall maintain the governor response capability to provide FREQUENCY RESPONSE throughout the commitment period.

7. **Metering and Communication.** An IOS SUPPLIER offering to provide FREQUENCY RESPONSE shall have frequency metering and generation output metering sufficient to determine on an after the fact basis that the generator delivered the response required.

3.6 SYSTEM BLACK START CAPABILITY

Sample Requirements – OPERATING AUTHORITY

The statements below are provided for information only and do not infer mandatory requirements or a description of industry practices.

1. **Restoration Plans.** The OPERATING AUTHORITY shall verify that restoration plans meet NERC, applicable Regional Reliability Council, and local requirements, and provide for adequate SYSTEM BLACK START CAPABILITY.
2. **System Black Start Requirements.** The OPERATING AUTHORITY shall determine the overall required amount and locations of SYSTEM BLACK START CAPABILITY in a system restoration plan for the coordinated re-energization of the transmission network following a total or partial system blackout.
3. **Training and Drills.** The OPERATING AUTHORITY shall include IOS RESOURCES providing SYSTEM BLACK START CAPABILITY in the conduct of system-wide training, and drills, as necessary to prepare a coordinated response to a partial or total system blackout condition.
4. **Provision of SYSTEM BLACK START CAPABILITY.** The OPERATING AUTHORITY shall ensure IOS RESOURCES for SYSTEM BLACK START CAPABILITY are arranged, provided, and deployed as necessary to reenergize the transmission network following a total or partial system blackout.
5. **Testing and Verification.** The OPERATING AUTHORITY shall schedule random testing or simulation, or both, to verify SYSTEM BLACK START CAPABILITY is operable according to the restoration plan. Testing and verification will be in accordance with established certification criteria. These tests and/or simulations shall ensure that the SYSTEM BLACK START CAPABILITY resources and the transmission system are configured such that the SYSTEM BLACK START CAPABILITY resources are able to energize the appropriate portions of the transmission system, and supply restoration power to the generator(s) or load(s), as required by the restoration plan. The SYSTEM BLACK START CAPABILITY resources must provide frequency and voltage within prescribed limits during line energization and remote load pickup.
6. **Performance Verification.** The OPERATING AUTHORITY shall verify the actual performance of SYSTEM BLACK START CAPABILITY resources in the event actual system blackout conditions occur.

Sample Requirements – IOS SUPPLIER

The statements below are provided for information only and do not infer mandatory requirements or a description of industry practices.

7. **IOS RESOURCE Capabilities.** An IOS SUPPLIER of SYSTEM BLACK START CAPABILITY shall provide the following:

- 7.1. Capability to start a self-starting unit within a time specified, from an initial dead station and auxiliary bus condition. Alternately, a SYSTEM BLACK START CAPABILITY resource may be a generating unit that is able to a) safely withstand the sudden and unplanned loss of synchronization with the BULK ELECTRIC SYSTEM and b) maintain generating capacity for a specified period of time.
- 7.2. Capability of re-energizing, within a time specified, the plant auxiliaries necessary to start one or more additional units, if the SYSTEM BLACK START CAPABILITY unit is planned as a cranking source for one or more of these additional units.
- 7.3. Capability of picking up external load within a specified time.
- 7.4. Stated MW capacity of the SYSTEM BLACK START CAPABILITY unit or units.
- 7.5. Capability of running the SYSTEM BLACK START CAPABILITY unit at stated MW capacity for a specified time from when the unit is started.
- 7.6. Frequency measurement at the SYSTEM BLACK START CAPABILITY unit to support the system restoration plan.
- 7.7. Frequency responsive capability to sustain scheduled frequency and remain stable during load pickup coordinated by the OPERATING AUTHORITY in accordance with the restoration plan.
- 7.8. Reactive supply and voltage control capability to maintain system voltage within emergency voltage limits over a range from no external load to full external load.
- 7.9. Participation in training and restoration drills coordinated by the OPERATING AUTHORITY.
- 7.10. Provision of voice and data communications with the OPERATING AUTHORITY, capable of operating without an external AC power supply for a specified time.

Section 4. Methods for IOS Performance Measurement and Certification

4.1 Introduction

This Section offers metrics for measuring the performance of IOS RESOURCES and certifying IOS-related capabilities. The metrics focus on the key parameters needed for reliability and test or measure these characteristics as precisely and efficiently as possible. The metrics described are examples of measures. Other measures may be valid and appropriate to achieve the same reliability objectives.

Performance measures assess the real-time delivery of a service by an IOS SUPPLIER. By design, the extent of the certification tests is inversely related to the ease of measuring real-time performance. For example, the certification test for the REGULATION is quite simple because REGULATION is delivered on a continuous basis. On the other hand, the certification test for the SYSTEM BLACK START CAPABILITY is more extensive because this service is rarely delivered, and, therefore, cannot routinely be measured. IOS that are deployed only occasionally (e.g., CONTINGENCY RESERVE) have a certification test that is more extensive than REGULATION but simpler than that for SYSTEM BLACK START CAPABILITY.

Performance measures can be monitored at the IOS SUPPLIER (i.e., aggregated) level. This allows the IOS SUPPLIER to meet performance requirements in a flexible manner while holding the IOS SUPPLIER accountable for the aggregate performance of its individual IOS RESOURCES. Certification requirements also potentially allow for a group or portfolio of physical assets to be certified in aggregate. However, if the IOS RESOURCES that comprise the portfolio are modified to the extent that the certified capabilities are affected, then re-certification should be necessary.

The performance metrics presented in this IOS Reference Document were developed to meet three criteria:

- Support reliability objectives of the OPERATING AUTHORITY (e.g., meet Policy 1 requirements for CPS and DCS);
- Be technically justified; and
- Operate well in a variety of regulatory frameworks and market structures and conditions.

Each performance metric includes three components. The *measure* (e.g., area control error) identifies the characteristic to be measured (analogous to miles per hour for a highway speed limit). The *criteria* bound the measure (e.g., CPS1 and 2 for area control error and 65 miles per hour for a speed limit). Finally, the metric may include *conditions* under which the measurements apply (e.g., the Policy 1 DCS measure applies only after a major contingency occurs and speed limits differ between rural freeways and urban roads). The criteria numbers are proposed as a starting point, and will likely need to be changed with experience.

4.2 Performance Measurement Methods

REGULATION and LOAD FOLLOWING Sample Performance Measures

IOS RESOURCES providing REGULATION and LOAD FOLLOWING service deliver capacity, MANEUVERABILITY, and energy to the BALANCING AUTHORITY. The measurement methods described below are intended to determine if sufficient capacity, maneuverability, and energy have been delivered

to maintain reliability.

The deviation between the output instructed by the BALANCING AUTHORITY, subject to the declared capabilities of the IOS RESOURCE, and the actual output of the IOS RESOURCE is defined as the SUPPLIER CONTROL ERROR (SCE). Each IOS SCE must be bounded within the SCPS1 and SCPS2 criteria as defined below.

Figure 5 below demonstrates the concept of Supplier Control Error as the deviation between instructed output, subject to declared capabilities, and actual output.

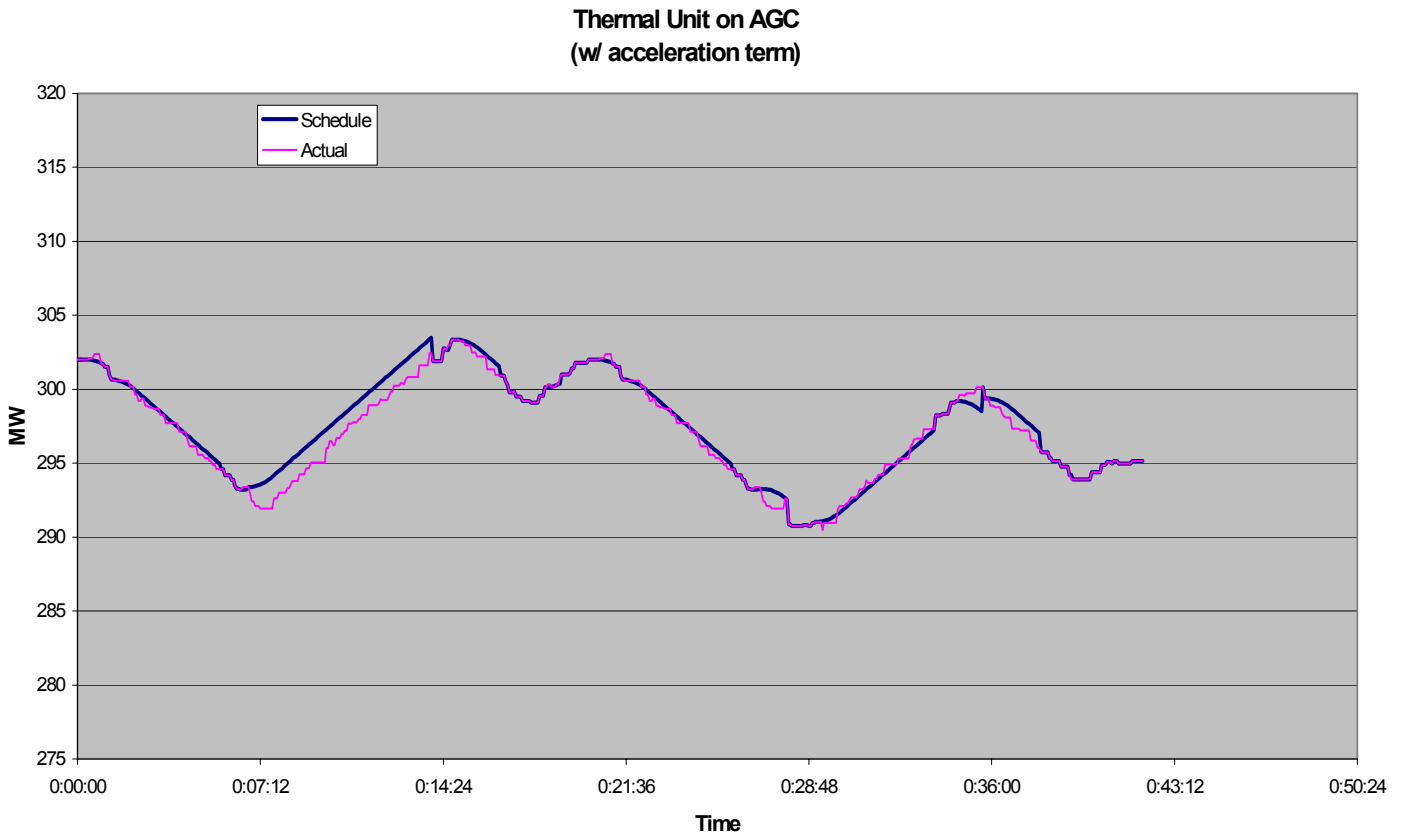

Figure 5 – Supplier Control Error: Deviation between Schedule and Actual Output

Figure 6 demonstrates one method for the determination of the scheduled output of a resource.

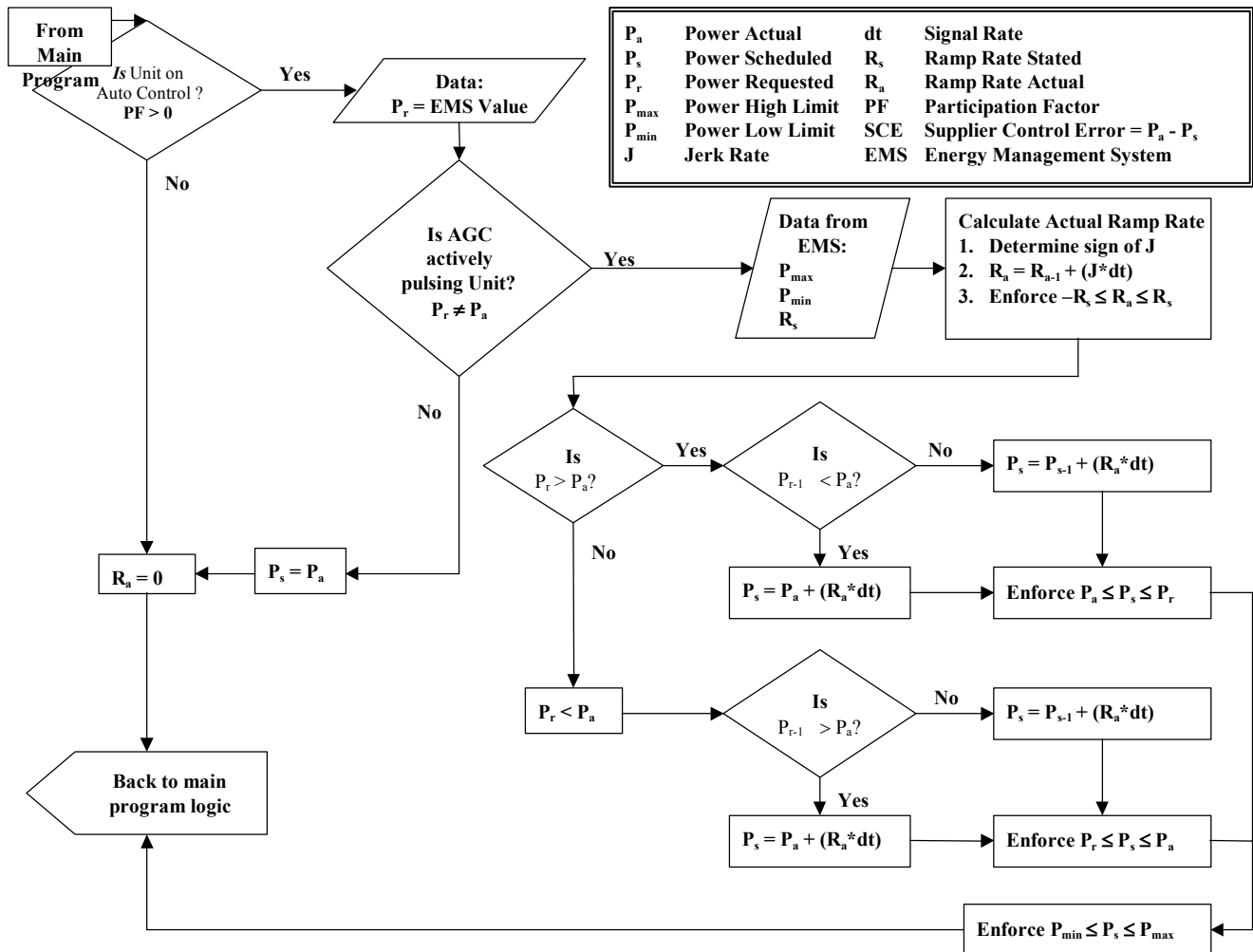

Figure 6 – Determination of IOS RESOURCE Schedule

Figure 7 provides one method for the calculation of SUPPLIER CONTROL ERROR (SCE).

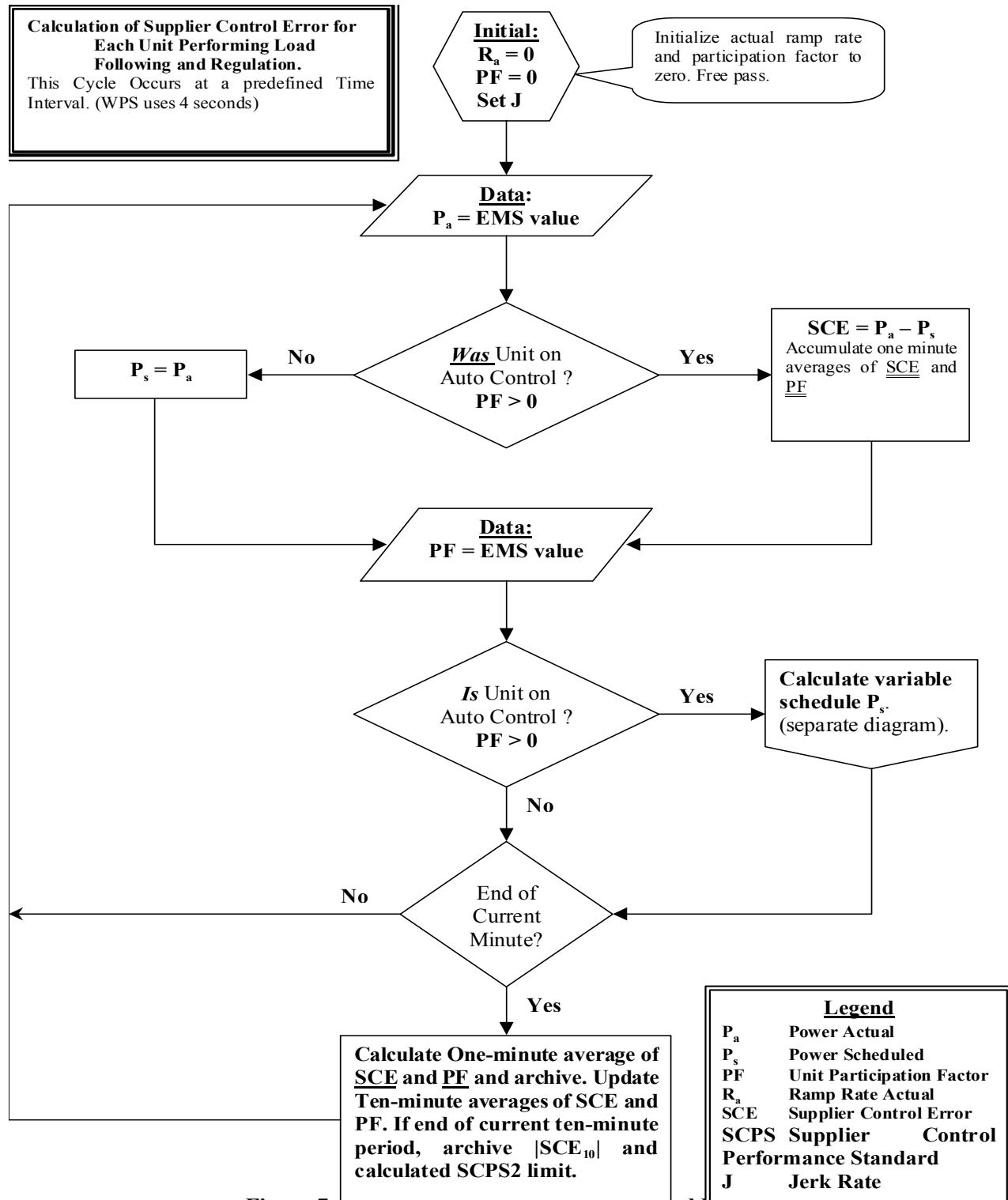

Figure 7 – Determination of Supplier Control Error

Consider that the control signal given to the IOS RESOURCE, subject to the stated capabilities of the IOS RESOURCE, constitute an agreed upon variable schedule. Deviation of actual output from this schedule is the measure of performance (the Supplier Control Error SCE). Compliance is measured with three criteria:

- SCPS1 (an analogy to Policy 1 CPS1)
- Covariance(SCE/pf,ACE) ≤ Limit
- Average(SCE) = 0
- SCPS2 (an analogy to Policy 1 CPS2)

Let us consider, in general terms, the SCPS2 criterion. This criterion requires that the IOS RESOURCE match its actual output to its schedule within a predefined bandwidth for 90% of all measurement periods (10-minute average). In equation form this criterion is described as follows:

$$SCPS2 = \left(\frac{\text{NumberofCompliantPeriods}}{\text{TotalNumberofPeriods}} \right) \geq 0.90$$

$$\text{CompliantPeriod} _ \text{when} _ |SCE_{10}| \leq L_{10} * \frac{\sqrt{\text{ParticipationFactor}}}{\sum_i \sqrt{\text{ParticipationFactor}_i}}$$

where: |SCE₁₀| is the 10-minute average of SCE
Participation Factor = Response Rate/(Sum of all Response Rates)
L₁₀ is the control area's CPS2 bound

By requiring the IOS RESOURCE to produce output within a bandwidth around the variable schedule, the SCPS2 criterion measures capacity and maneuverability. Unfortunately, the SCPS2 criterion alone is insufficient. An IOS RESOURCE could consistently produce at the bottom of the bandwidth. This would violate the “energy” attribute of the service. In addition, the IOS RESOURCE could systematically time its errors within the bandwidth to the detriment of reliability: overproducing during times of plenty and underproducing during times of shortage. To address these two short comings of SCPS2, another criterion is required.

Let us consider, in general terms, the SCPS1 criterion. This criterion requires that the IOS RESOURCE match its actual output to its schedule such that (1) in the long run the scheduled energy equals the actual energy and (2) the timing of the error with respect the control area ACE or the Frequency Error is sufficiently favorable to maintain reliability. In equation form the criteria are described as follows:

$$Avg_{month}(SCE_1) \approx 0$$

And:

$$SCF = AVG(month) \left[\left(\frac{SCE_1}{\text{ParticipationFactor}} \right) * \left(\frac{\Delta F_1}{(-10 * Bias) * \varepsilon^2_1} \right) \right]$$

or:

$$SCF = AVG(month) \left[\left(\frac{SCE_1}{\text{ParticipationFactor}} \right) * \left(\frac{ACE_1}{\gamma^2_1} \right) \right]$$

With:

$$SCPS1 = (2 - SCF)$$

where: SCE_1 is the one minute average Supplier Control Error

Participation Factor = Response Rate/(Sum of all Response Rates)

ΔF_1 is the one-minute average frequency error

Bias is the control area bias

ϵ_1 is NERC Policy 1 CPS1 limit

ACE_1 is the control area's one-minute average area control error

γ_1 is the IOS SUPPLIER limit determined by NERC. This value uniquely modifies ϵ_1 for each control area depending on its correlation between ACE and ΔF .

(note: the specific limit for SCPS1 score is not set forth in this document. Limits between 180% and 200% have been proposed.)

The IOS RESOURCE that is compliant with SCPS1 and SCPS2 operates within a bandwidth, delivers the correct amount of energy, and does not time its errors in a manner detrimental to reliability. This assures that the service attributes of capacity, maneuverability, and energy have been adequately delivered.

Figures 8 and 9 demonstrate the SCPS1 and SCPS2 performance evaluation of 15 units on a sample system.

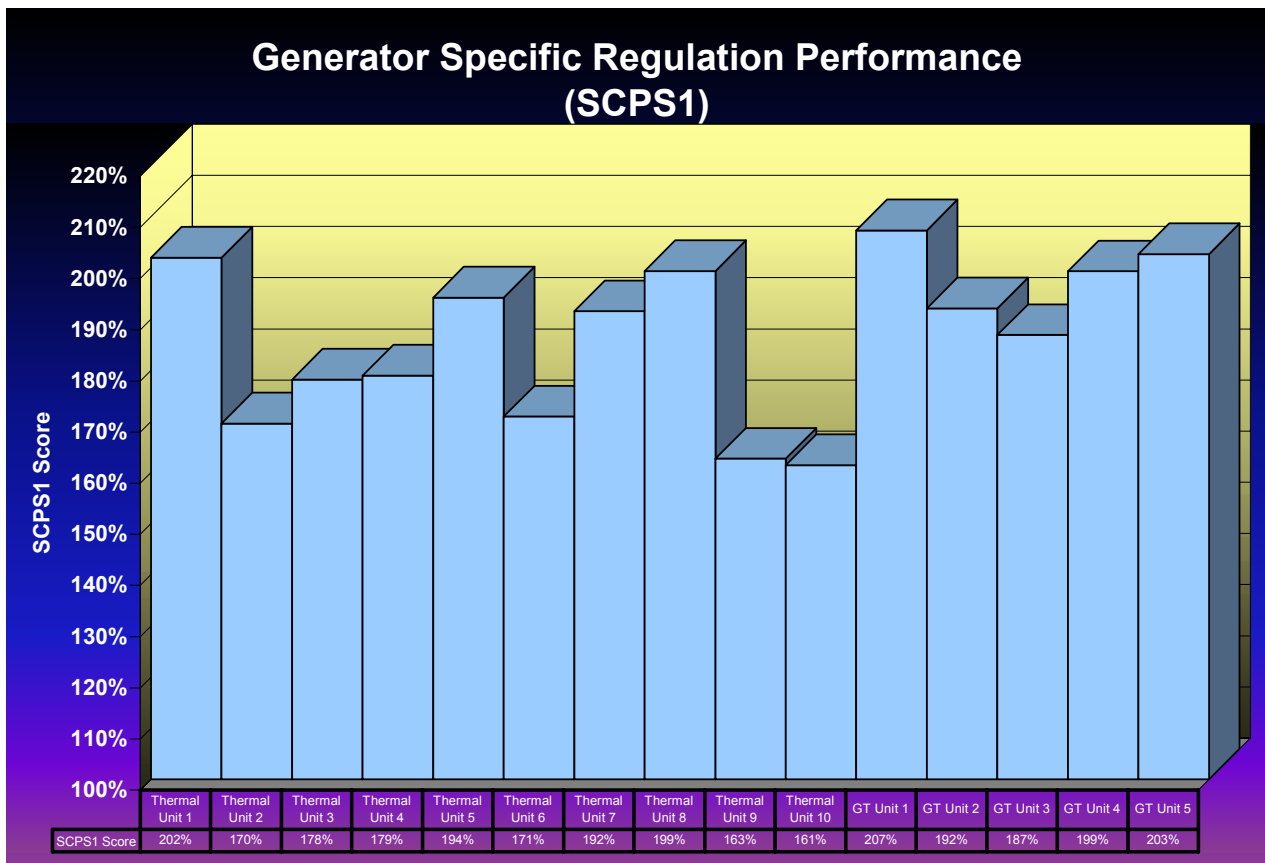

Figure 8 – Sample Regulation SCPS1 Performance Measures for IOS Resources

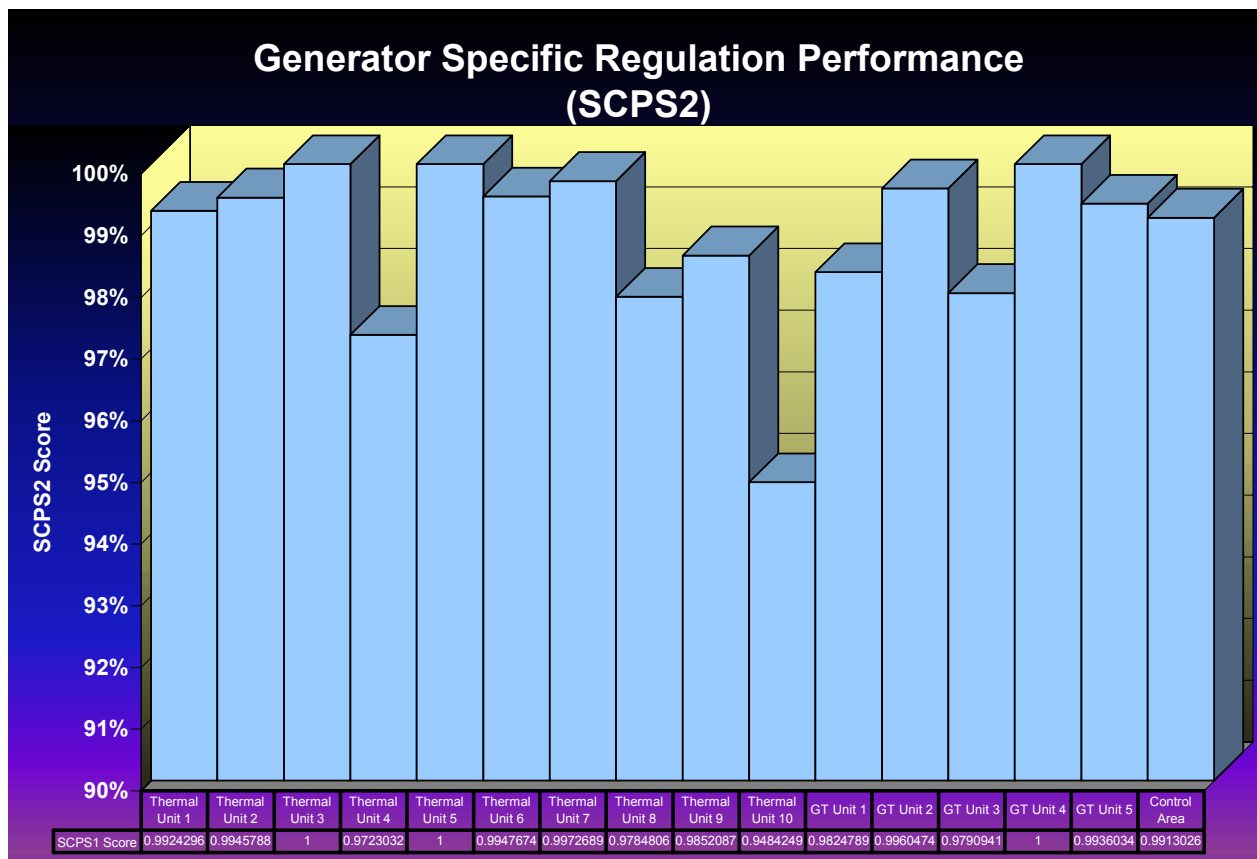

Figure 9 - Sample Regulation SCPS2 Performance Measures for IOS Resources

From this information, one may also determine the Regulation participation of individual IOS Resources, as shown in Figure 10.

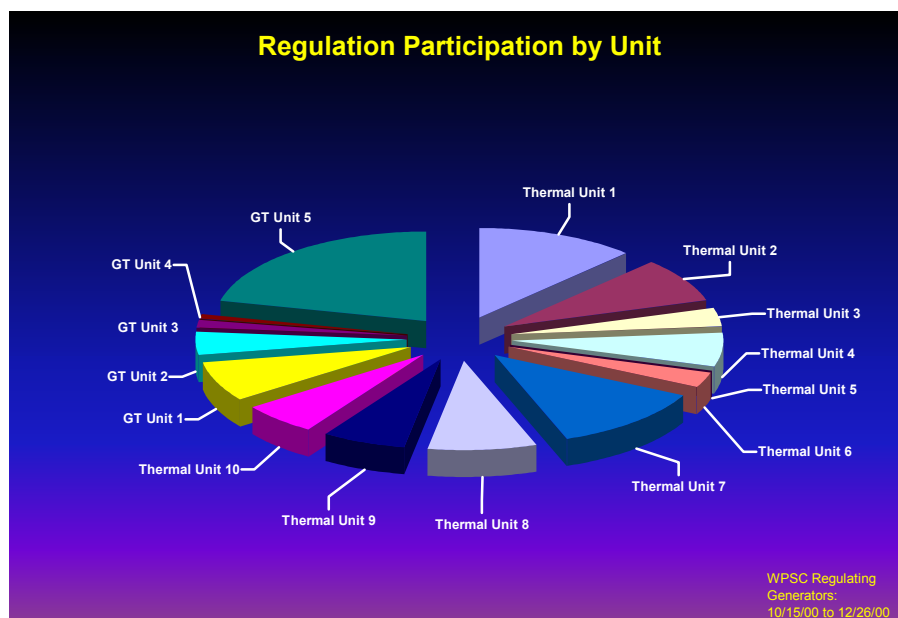

Figure 10 – Sample Determination of Regulation Participation

Additionally, this information allows one to determine the contribution of Supplier performance to the

Control Area's CPS1 score, shown in Figure 11.

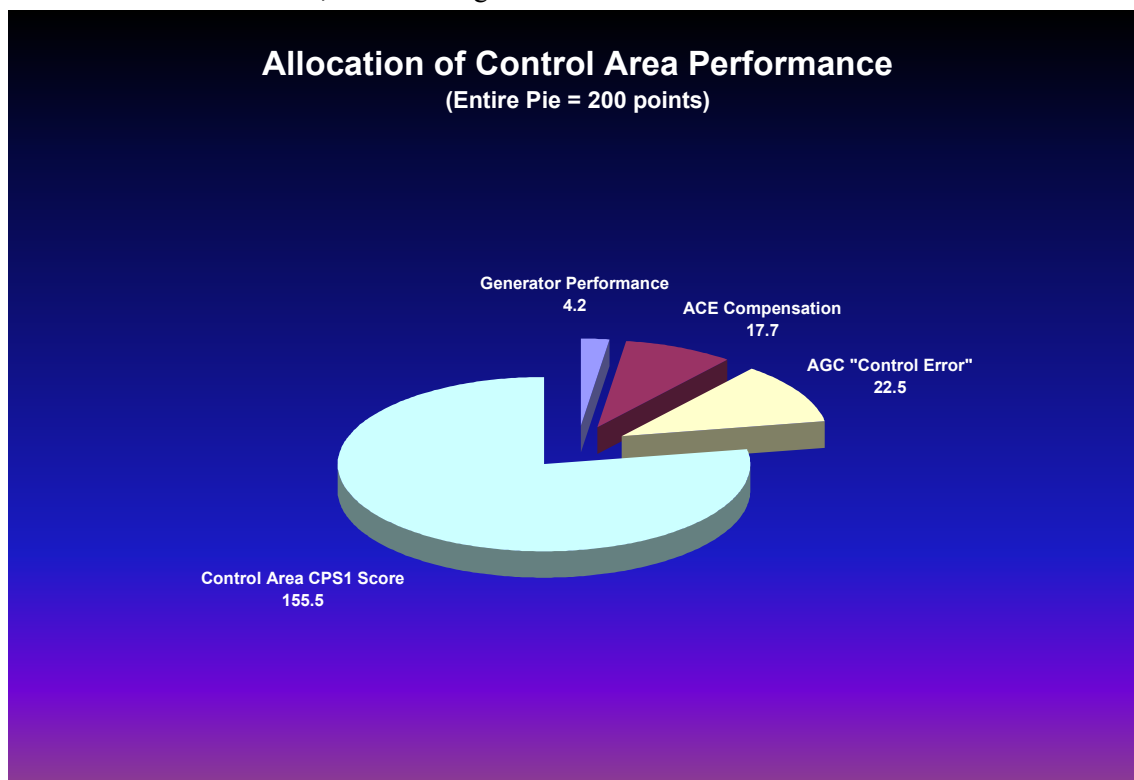

Figure 11 – Sample Determination of Regulation Participation

CONTINGENCY RESERVE Sample Performance Measures

In response to the instructions of the BALANCING AUTHORITY, and subject to the declared capabilities of the IOS RESOURCE, the IOS RESOURCE shall provide at least 100%, and not greater than 120%, of the stated real power (MW) amount within ($T_{DCS} - X$) minutes of the receipt of the instructions. The variable "X" is the OPERATING AUTHORITY notification delay. Furthermore, the IOS RESOURCE shall maintain between 100% and 120% of the stated real power (MW) amount for the 20 minutes (or for the CONTINGENCY RESERVE deployment period) following T_{DCS} . Finally, the IOS RESOURCE shall go to within 90% to 110% of its post-contingency scheduled output, subject to the declared capabilities of the IOS RESOURCE, within 10 minutes following instructions from the OPERATING AUTHORITY.

For each IOS RESOURCE providing CONTINGENCY RESERVES, the BALANCING AUTHORITY shall measure and record for the entire duration of the CONTINGENCY RESERVE deployment the one-minute averages of real power output and the instructed output, subject to the declared capabilities of the IOS RESOURCE.

The expected performance criteria are that the IOS RESOURCE loads, sustains, and unloads the stated CONTINGENCY RESERVE amount in MW, within the allowed band-width of 100% to 120%, in the time periods stated in the standard:

- Loads instructed CONTINGENCY RESERVES within ($T_{DCS} - X$) minutes,
- Sustains instructed CONTINGENCY RESERVES for the 20 minutes following ($T_{DCS} - X$) minute loading window, and
- Unloads instructed CONTINGENCY RESERVES within 10 minutes of instruction to unload and goes to

within 90% to 110% of post-contingency scheduled output, subject to stated capabilities of the IOS RESOURCE.

REACTIVE POWER SUPPLY FROM GENERATION SOURCES Sample Performance Measures

IOS RESOURCES shall meet, within established tolerances, and respond to changes in the voltage or reactive power schedule established by the OPERATING AUTHORITY, subject to the stated IOS RESOURCE reactive and real power operating characteristic limits and voltage limits.

An IOS RESOURCE shall operate with the unit's AVR in use during the schedule period in which REACTIVE POWER SUPPLY FROM GENERATION SOURCES is provided, unless specifically directed to operate in manual mode by the OPERATING AUTHORITY, or a need to operate in manual mode is identified for emergency reasons by the IOS SUPPLIER.

IOS RESOURCES shall maintain stated reactive capacity, both leading and lagging. An IOS RESOURCE's stated lagging reactive capacity shall be supplied without interruption or degradation when subject to sudden and large voltage drops.

When an IOS RESOURCE is controlling to a voltage setpoint under steady state conditions, the IOS RESOURCE Voltage Schedule Error ($V_{ACTUAL} - V_{SCHEDULE}$) shall be measured and reported quarterly by the OPERATING AUTHORITY once per each 10-minute period during all scheduling periods in which the IOS RESOURCE is providing the service. 98% of Voltage Schedule Errors Reported in Quarter are within Voltage Tolerance ($\pm 2\%$ of Scheduled), subject to stated capabilities of IOS RESOURCE.

When an IOS RESOURCE is controlling to reactive power output under steady state conditions, the IOS RESOURCE Reactive Power Output Error ($VAR_{ACTUAL} - VAR_{SCHEDULE}$) shall be measured and reported quarterly by the OPERATING AUTHORITY once per each 10-minute period during all scheduling periods in which the IOS RESOURCE is providing the service. 95% of Reactive Power Output Errors Reported in Quarter are within Reactive Tolerance ($\pm 10\%$ of Scheduled), subject to stated capabilities of IOS RESOURCE.

The status of the AVR shall be reported quarterly by the IOS SUPPLIER to the OPERATING AUTHORITY for the entirety of all scheduling periods in which the IOS RESOURCE is providing the service. AVR is on and operating automatically at least 98% of the time in which the IOS RESOURCE is providing the service. Percentage is calculated as: Time AVR is on While Providing IOS/Total Time Providing IOS X 100%

FREQUENCY RESPONSE Sample Performance Measures

In response to the deviations in system frequency, and subject to the declared capabilities of the IOS RESOURCE such as dead-band and droop, the IOS RESOURCE shall increase or decrease its output according to its stated response characteristic.

For all frequency deviations exceeding the NERC frequency excursion values (Policy 1 epsilon values times an Interconnection-specific factor), the OPERATING AUTHORITY shall measure and record scan rate (e.g. AGC scan rate) values of real power output for the IOS RESOURCE providing FREQUENCY RESPONSE. The OPERATING AUTHORITY shall measure and record the MW data beginning one minute prior to the start of the frequency excursion event until one minute after the start of the frequency excursion event. Compliance is measured by comparing the actual response to the declared frequency response capability.

SYSTEM BLACK START CAPABILITY Sample Performance Measures

The IOS SUPPLIER shall maintain certified SYSTEM BLACK START CAPABILITY IOS RESOURCES, with the declared capacity and capabilities of the IOS RESOURCES, continuously during all periods in which SYSTEM BLACK START CAPABILITY is provided. During a system restoration emergency, the IOS SUPPLIER shall respond to the instructions of the OPERATING AUTHORITY, subject to the declared capacity and capabilities of the SYSTEM BLACK START CAPABILITY IOS RESOURCES.

The following performance measures may be monitored during an emergency: During emergency activation and in response to instructions of the OPERATING AUTHORITY, the IOS RESOURCE is able to start and synchronize to the power system within the agreed upon time, and is able to provide full declared real and reactive power capabilities.

4.3 Certification Methods

Introduction to Certification Methods

Certification is a means to demonstrate the capability of an IOS Resource to deliver an IOS. Certification increases reliability since it offers assurances to all industry participants that promised capabilities can be deployed and utilized when needed for reliability reasons. In practice, the cost and effort of a certification program needs to be balanced against the reliability impact should the promised capabilities not be delivered when requested, and the probability of delivery shortfalls.

REGULATION and LOAD FOLLOWING may be continuously measured. Therefore no certification requirements are suggested beyond the general certification requirements for all IOS. This section contains sample certification methods for CONTINGENCY RESERVE, REACTIVE POWER SUPPLY FROM GENERATION SOURCES, FREQUENCY RESPONSE, and SYSTEM BLACK START CAPABILITIES.

OPERATING AUTHORITY Sample IOS Program Certification

The following certification requirements of the OPERATING AUTHORITY should be verified annually through self-assessment and every three years by an entity external to the OPERATING AUTHORITY:

Documentation shows that the OPERATING AUTHORITY has developed and is maintaining and executing a program to specify and provide IOS in accordance with the referenced requirements of Section 3.

The following minimum elements should be considered in the review of documentation of the OPERATING AUTHORITY's IOS program. The documentation review should specifically include each OPERATING AUTHORITY requirement in Section 3 of the IOS Reference Document.

1. A detailed plan and procedures to assure sufficient IOS are arranged, provided, and deployed to meet NERC, Regional Reliability Council, and local planning and operating standards.
2. Detailed specifications of the OPERATING AUTHORITY's requirements for IOS, which have been determined through an open and inclusive process that is consistent with regulatory requirements, is coordinated at a regional level, includes market stakeholders, and allows for dispute resolution. The specifications shall include, but are not limited to:
 - 2.1. The quantity, response time, duration, location and other criteria for each IOS.

- 2.2. Written procedures for the arrangement, provision, and deployment of IOS.
 - 2.3. Metering requirements.
 - 2.4. Voice and data communication requirements associated with provision and deployment of IOS.
 - 2.5. Specification of the transmission service requirements for delivery of each IOS.
3. Procedures for adapting the IOS requirements to maintain system reliability in response to current or expected system conditions.
 4. Publication of IOS requirements in publicly available documents that specify the OPERATING AUTHORITY's IOS requirements and procedures.
 5. Procedures for monitoring the actual performance of IOS RESOURCES under normal and/or disturbance conditions to verify the IOS RESOURCE meets published performance criteria.

General Certification – Sample Criteria

The following are sample certification requirements that could apply to all IOS. These requirements would be evaluated by audit or other means of verification.

1. **Metering** – An IOS SUPPLIER shall provide and maintain metering to measure IOS capabilities and performance, as specified by published IOS requirements.
2. **Voice and Data Communications** – An IOS SUPPLIER shall provide and maintain voice and data communications, as specified by published IOS requirements, to enable:
 - 2.1. IOS RESOURCES to respond to the instructions or controls of the OPERATING AUTHORITY.
 - 2.2. OPERATING AUTHORITIES to monitor the capabilities and verify the performance of IOS RESOURCES.

CONTINGENCY RESERVE Certification Method

The following is a sample certification test for CONTINGENCY RESERVE – SPINNING and SUPPLEMENTAL:

1. A test for CONTINGENCY RESERVE – SPINNING or SUPPLEMENTAL shall be performed during a continuous 8-hour window agreed upon by the IOS SUPPLIER and the BALANCING AUTHORITY.
2. The BALANCING AUTHORITY shall confirm the date and time of the test with the IOS RESOURCE using both the primary and alternate voice circuits to validate the voice circuits.
3. At any time during the eight-hour window, selected by the BALANCING AUTHORITY, and not previously disclosed to the IOS SUPPLIER, the BALANCING AUTHORITY shall send a signal to the IOS RESOURCE requesting it to provide its declared amount of CONTINGENCY RESERVE – SPINNING OR SUPPLEMENTAL.
4. The IOS RESOURCE output shall be measured as clock-minute average outputs for a) the clock-minute prior to the instructions being received from the BALANCING AUTHORITY; b) the clock-minute following receipt of instructions from the BALANCING AUTHORITY and continuing for $T_{DCS} - X$ minutes (where T_{DCS} is the number of minutes allowed by the Policy 1 Disturbance Control

Standard for recovery from a major outage and X is the previously agreed upon time that the BALANCING AUTHORITY requires to identify the need to deploy the reserves and to notify the IOS RESOURCE); c) and for each of the subsequent 19 clock-minutes. All measurements shall be between 100% to Y% of the declared amount of CONTINGENCY RESERVE, where Y is an INTERCONNECTION-specific factor.

REACTIVE POWER SUPPLY FROM GENERATION SOURCES Certification

The following is a sample certification test for REACTIVE POWER SUPPLY FROM GENERATION SOURCES:

1. The IOS RESOURCE shall perform the unit automatic voltage regulator (AVR) tests, and supply IOS RESOURCE AVR data as required by the NERC Planning Standards “System Modeling Data Requirements, Generation Equipment.” Sections 2B, Measurement 4, and 2B, Measurement 6. The AVR tests will be performed upon initial certification, and periodically at an OPERATING AUTHORITY set time interval no more often than once every five years. The AVR tests are run at a time mutually agreed upon in advance by the IOS SUPPLIER and the OPERATING AUTHORITY.
2. The IOS RESOURCE must verify and maintain its stated reactive capacity, as required by the NERC Planning Standards “System Modeling Data Requirements, Generation Equipment.” Sections 2.B, Measurement 3. This reactive capacity certification test will verify the IOS RESOURCE reactive capacity. The reactive capacity test will be performed upon initial certification, and periodically at an OPERATING AUTHORITY set time interval no more often than once every five years. The reactive capacity test is run at a time mutually agreed upon in advance by the IOS SUPPLIER and the OPERATING AUTHORITY. The test results, as described in 2.B, Measurement 3, shall be communicated to the OPERATING AUTHORITY.

FREQUENCY RESPONSE Certification

The following is a sample certification test for FREQUENCY RESPONSE:

1. The BALANCING AUTHORITY shall confirm the date and time of the test with the IOS RESOURCE. The FREQUENCY RESPONSE test should be performed at a time that is mutually agreed upon by the IOS SUPPLIER and BALANCING AUTHORITY.
2. Because it is impractical to move INTERCONNECTION frequency for test purposes, it is necessary to use simulated frequency excursions outside the allowed deadband to perform a certification test of the IOS RESOURCE. A test frequency signal will be provided to the IOS RESOURCE and the IOS RESOURCE’S response will be measured. The frequency value of the test signal will be calculated to require the full response amount (MW) being certified, based on the IOS RESOURCE’S deadband and droop characteristic. The pre-contingency output (or consumption) of the IOS RESOURCE shall be calculated as the average power recorded for the clock minute prior to the injection of the test frequency signal. After each frequency test signal is injected, the test measurements shall include the MW output (or consumption) ten seconds after the frequency change and the average for each clock-minute from ten seconds through ten minutes following each frequency change. To pass the test, the measured values must differ from the pre-contingency output (or consumption) within the bounds listed in the FREQUENCY RESPONSE criteria.
3. It may be necessary to construct alternative tests for IOS RESOURCES that cannot produce (or consume) real power while connected to a test frequency source. In this case, output (or consumption) may be calculated based upon measured performance of that portion of the system that

can be tested (throttle valve position, for example). Testing requirements should be negotiated between the IOS SUPPLIER and the BALANCING AUTHORITY.

SYSTEM BLACK START CAPABILITY Certification

The following sample SYSTEM BLACK START CAPABILITY certification tests are divided into three parts, depending on the frequency of testing required.

Basic Starting Test – The basic ability of the IOS RESOURCE to start itself, without support from the grid, should be tested at least once every three years. The test is run during a one-week period mutually agreed upon in advance by the IOS SUPPLIER and OPERATING AUTHORITY. The test itself does not require one week, but may be called by the OPERATING AUTHORITY any time during the week.

1. The OPERATING AUTHORITY shall confirm the dates of the test with the IOS SUPPLIER.
2. At a time during the one-week test window, selected by the OPERATING AUTHORITY, and not previously disclosed to the IOS RESOURCE:
 - 2.1. The IOS RESOURCE, including all auxiliary loads, will be isolated from the power system;
 - 2.2. Within the agreed upon time of being directed to do so by the OPERATING AUTHORITY, the IOS RESOURCE will start without assistance from the system; and
 - 2.3. The IOS RESOURCE must remain stable (both frequency and voltage) while supplying only its own auxiliary loads or loads in the immediate area for at least 30 minutes.

Line Energizing Test – The ability of the IOS RESOURCE to energize transmission will be tested when conditions permit (during transmission maintenance, for example) but at least once every three years. Tests will be conducted at a time mutually agreed upon by the IOS SUPPLIER and the OPERATING AUTHORITY. If an actual Line Energizing Test is impractical or presents a condition that may pose an undesired risk of load service interruption, these tests may be conducted by steady state and dynamic computer simulation. It should be noted, however, that impediments to system restoration may occur that are not fully modeled in simulations.

1. Sufficient transmission will be de-energized such that when it is picked up by the IOS RESOURCE it demonstrates the IOS RESOURCE'S ability to energize enough transmission to deliver required output to the generator or load that the restoration plan calls for this IOS RESOURCE to supply. The OPERATING AUTHORITY shall be responsible for transmission connections and operations that are compatible with the capabilities of the IOS RESOURCE.
2. Conduct a **Basic Starting Test**.
3. The CONTROL AREA will direct the IOS RESOURCE to energize the previously de-energized transmission, while monitoring frequency and voltages at both ends of the line. Alternatively, if the OPERATING AUTHORITY agrees, the transmission line can be connected to the IOS RESOURCE before starting, allowing the resource to energize the line as it comes up to speed. This avoids the energizing surge.
4. The IOS RESOURCE must remain stable (both frequency and voltage) while supplying only its own auxiliary loads or external loads and controlling voltage at the remote end of the transmission line

for at least 30 minutes.

Load Carrying Test – The ability of the IOS RESOURCE to remain stable and to control voltage and frequency while supplying restoration power to the generator or load that the restoration plan calls for this IOS RESOURCE to supply shall be tested as conditions permit, but at least once every six years. If an actual Load Carrying Test is impractical or presents a condition that may pose an undesired risk of load service interruption, these tests may be conducted by steady state and dynamic computer simulation. It should be noted, however, that impediments to system restoration may occur that are not fully modeled in simulations.

1. Conduct a **Basic Starting Test**.
2. Conduct a **Line Energizing Test**.
3. The OPERATING AUTHORITY will direct picking up sufficient load at the remote end of the isolated transmission system to demonstrate the IOS RESOURCE'S capability to supply the required load identified in the restoration plan, while maintaining voltage and frequency for at least 30 minutes.